

For construction in non-cyclonic areas  
Wind rating: N2 as per AS4055-2021.  
If you require a higher wind rating please contact  
us: admin@absco.com.au or 1800 029 701

NOTE: This shed can be upgraded to wind  
rating: C1 as per AS4055-2021 with the additional  
purchase of a Cyclone Kit.

When laying concrete slab, ensure there  
is a rebated edge 25mm deep around  
the perimeter. This will help water egress  
from the base of the shed.

### PLEASE LEAVE A REVIEW

Tell us about your experience!  
Visit [www.absco.sheds.com.au/review](http://www.absco.sheds.com.au/review)

## GENERAL INSTRUCTIONS

- Before commencing any assembly, read through these instructions in detail to gain a thorough understanding of assembly methods and associated details.
- Unpack the carton and carefully identify and check off all the parts against the parts described and illustrated on "COMPONENTS PACKING LIST" pages.
- Local authority approval must be obtained prior to construction of the shed. Once you have selected your site you will need to lodge a site plan to your local council.

## SITE PREPARATION

- The site for the shed must be level. An uneven surface may result in misalignment of parts.
- The shed shall be erected on top of a reinforced concrete slab and anchored down appropriately illustrated on "FINAL CONSTRUCTION" page. **If using a rebated slab ensure that all frame uprights are trimmed 25mm.**

## TOOLS REQUIRED

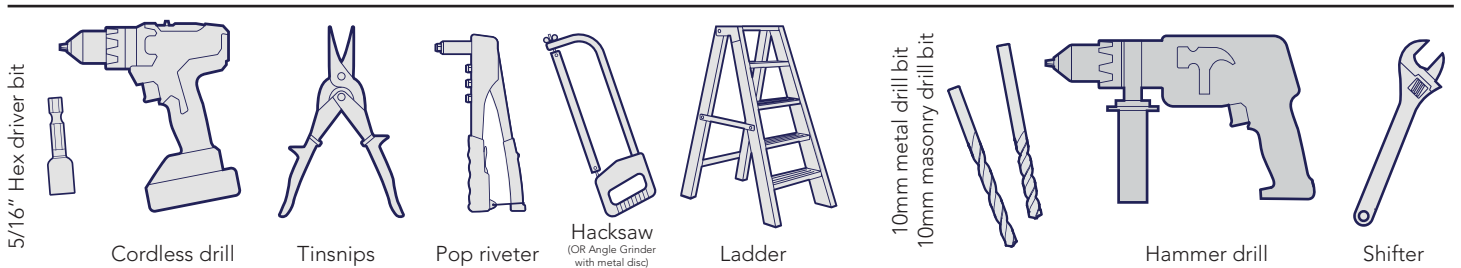

## SAFETY NOTES











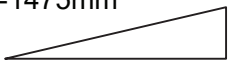

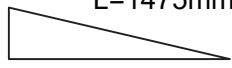
- Some parts may have sharp edges. It is advisable to wear gloves when handling these items and safety glasses if drilling holes. Sensible shoes are highly recommended.
- Do not erect your shed in windy conditions.
- It is highly recommended to erect the shed with two or more people.
- Do not sit, stand or walk on the roof of your shed.

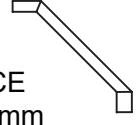
## RECOMMENDED

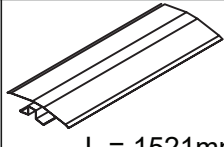

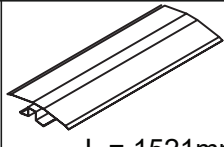









## COMPONENT PACKING LIST

Check off all components.

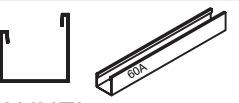

MAIN PACK CARTON (PACK 1 OF 3)							
QTY	COMPONENT DESCRIPTION	PART No.	CHECK	QTY	COMPONENT DESCRIPTION	PART No.	CHECK
2	 STEEL SHEET 1974mm X 773mm	H26		2	GABLE L/H L=1475mm 	16L	
1	 STEEL SHEET 1974mm X 773mm	F		2	GABLE R/H L=1475mm 	16R	
16	 STEEL SHEET 1546mm X 773mm	45A		2	BRACE L= 393mm 	13A	
2	 STEEL SHEET 2034mm X <u>329mm</u>	H39B		2	 RIDGE BEAM L = 1521mm	97AL	
2	 STEEL SHEET 1974mm X <u>711mm</u>	H37		2	 RIDGE BEAM L = 1521mm	97AR	
1	 STEEL SHEET 2034mm X 731mm	H32		3	 RIDGE BEAM JOINER L: 450mm (17.7")	ZARSP	
1	 STEEL SHEET 2034mm X 731mm	H33					
1	FITTINGS & ACCESSORIES PACKET (SEE PAGES 6 & 7)			1	CHANNEL SET PACKET (SEE PAGES 4 & 5)		

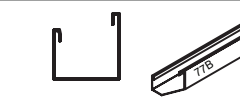
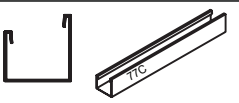
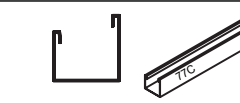
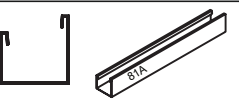
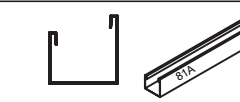
Nominal sheet widths are shown. +/- 2mm is within tolerance.

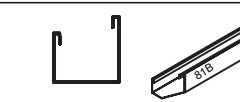



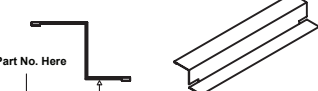
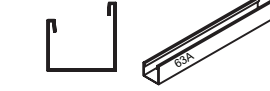
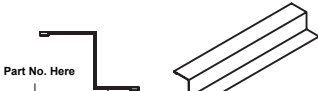

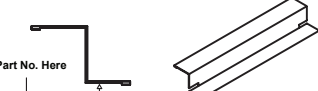
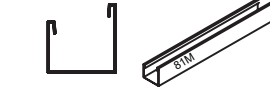
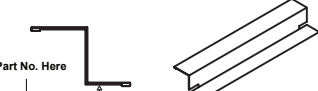
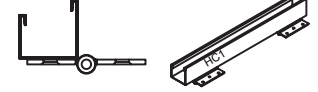
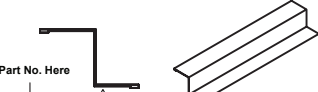
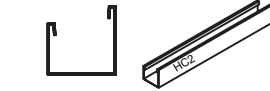
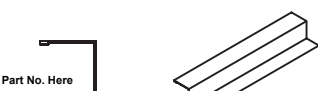
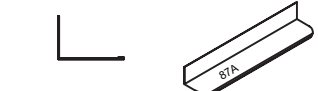
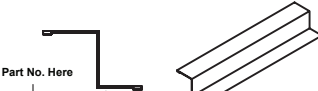



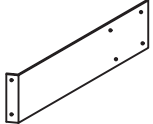

**COMPONENT PACKING LIST**

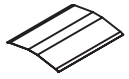
CHANNEL SET							
QTY	COMPONENT DESCRIPTION	PART No.	CHECK	QTY	COMPONENT DESCRIPTION	PART No.	CHECK
<b>3</b>	 CHANNEL L = 1496.5mm	<b>55BL</b>		<b>3</b>	 CHANNEL L = 1496.5mm	<b>55BR</b>	
<b>1</b>	 CHANNEL L = 1496.5mm	<b>56AL</b>		<b>1</b>	 CHANNEL L = 1496.5mm	<b>56AR</b>	
<b>1</b>	 CHANNEL L = 1496.5mm	<b>56BL</b>		<b>1</b>	 CHANNEL L = 1496.5mm	<b>56BR</b>	
<b>4</b>	 CHANNEL L = 1496.5mm	<b>60AL</b>		<b>4</b>	 CHANNEL L = 1496.5mm	<b>60AR</b>	
<b>1</b>	 CHANNEL L = 1496.5mm	<b>77BL</b>		<b>1</b>	 CHANNEL L = 1496.5mm	<b>77BR</b>	
<b>1</b>	 CHANNEL L = 1496.5mm	<b>77CL</b>		<b>1</b>	 CHANNEL L = 1496.5mm	<b>77CR</b>	
<b>5</b>	 CHANNEL L = 1496.5mm	<b>81AL</b>		<b>5</b>	 CHANNEL L = 1496.5mm	<b>81AR</b>	
<b>3</b>	 CHANNEL L = 1496.5mm	<b>81BL</b>		<b>3</b>	 CHANNEL L = 1496.5mm	<b>81BR</b>	

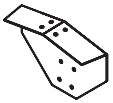

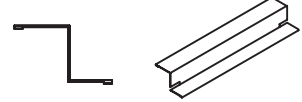
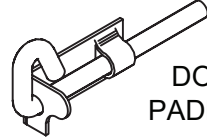
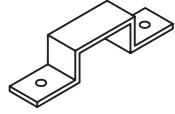



**COMPONENT PACKING LIST**

CHANNEL SET (CONTINUED)							
QTY	COMPONENT DESCRIPTION	PART No.	CHECK	QTY	COMPONENT DESCRIPTION	PART No.	CHECK
<b>2</b>	 CHANNEL L = 773mm	<b>58C</b>		<b>1</b>	 Part No. Here JAMB L= 788mm	<b>90B</b>	
<b>4</b>	 CHANNEL L = 1155mm	<b>63A</b>		<b>2</b>	 Part No. Here JAMB L= 1120mm	<b>91A</b>	
<b>1</b>	 CHANNEL L = 788mm	<b>79B</b>		<b>1</b>	 Part No. Here JAMB L= 1537mm	<b>93L</b>	
<b>2</b>	 CHANNEL L = 329mm	<b>81M</b>		<b>1</b>	 Part No. Here JAMB L= 797mm	<b>93R</b>	
<b>3</b>	 CHANNEL WITH HINGES L = 1974mm	<b>HC1</b>		<b>3</b>	 Part No. Here JAMB L= 2034mm	<b>HJ1</b>	
<b>2</b>	 CHANNEL L = 1974mm	<b>HC2</b>		<b>1</b>	 Part No. Here JAMB L= 2034mm	<b>HJ2</b>	
<b>4</b>	 LIP TRIM L= 1546mm	<b>87A</b>		<b>1</b>	 Part No. Here JAMB L= 1974mm	<b>HJ3</b>	

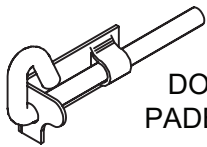
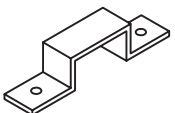

**COMPONENT PACKING LIST**

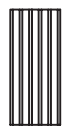
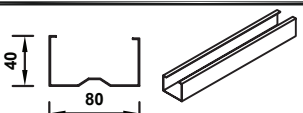
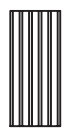
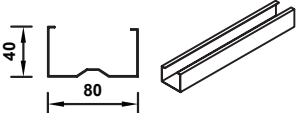
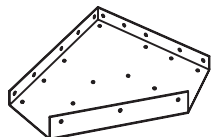
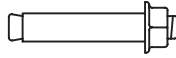
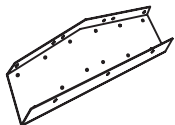
FITTINGS & ACCESSORIES PACKET CONTENTS							
QTY	COMPONENT DESCRIPTION	PART No.	CHECK	QTY	COMPONENT DESCRIPTION	PART No.	CHECK
1	DOUBLE DOOR KIT (SEE BELOW)			1	ASSEMBLY INSTRUCTIONS		
1	SINGLE DOOR KIT (SEE OVER)						
2	 CAP GABLE L: 170mm	14A		24	 HEX HD TEK SCREW W/ NEO WASHER 10-16x16mm		
3	 DOOR STRAP L: 165mm	12A		1	 3mm (0.12") DRILL BIT		
1	 RIDGE CAP JOINER	98A		1	 PHILLIPS HEAD DRIVER		
5	 RIDGE PLATES	RBP					
19	 CHANNEL JOINER L= 200mm (7.9")	CSJ		4	 JAMB L= 75mm	93B	
DOUBLE DOOR KIT PACKET CONTENTS							
3	 DOOR PADBOLT	22A		2	DOOR PADBOLT HASP 		
1	 SELF TAPPING SCREWS PACKET CONTAINING 220			8	 3/16 ROUND HEAD BOLTS & NYLOCK NUTS		
12	 3/16 COUNTERSUNK SCREWS & NUTS			12	 3.2 x 8mm BLIND POP RIVETS		

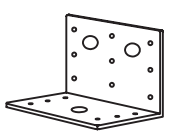
**COMPONENT PACKING LIST**

SINGLE DOOR KIT PACKET CONTENTS							
1		DOOR PADBOLT	22A		1	DOOR PADBOLT HASP	
1		SELF TAPPING SCREWS PACKET CONTAINING 220			12	3.2 x 8mm BLIND POP RIVETS	
12		3/16 COUNTERSUNK SCREWS & NUTS					
MAIN PACK CARTON (PACK 2 OF 3)							
5		STEEL SHEET 2034mm X 773mm	H30		4	 CHANNEL L = 1954mm	C1954
12		STEEL SHEET 2034mm X 773mm	H31		1	HIGH-PORTAL PACK (SEE BELOW)	
4	 40 80	CHANNEL L = 1482mm	C1482				
HIGH-PORTAL FRAME ACCESSORIES							
4		KNEE PLATE			8		10mm DYNABOLT
4		APEX PLATE			300		16mm TEK SCREWS
4		MULTI PURPOSE BRACKET					

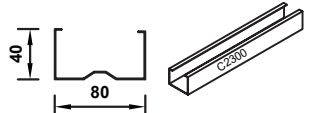
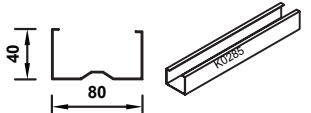
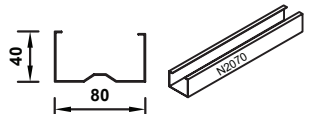
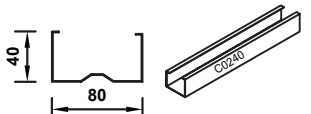
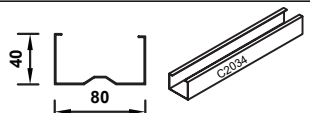
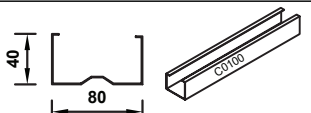
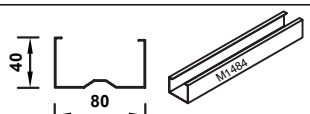
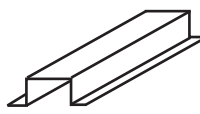
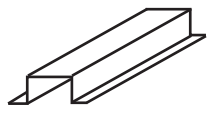
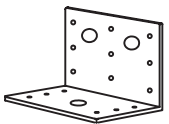
**COMPONENT PACKING LIST**

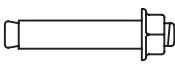
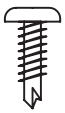
HIGH GARAGE-FRONT FRAME PACK							
QTY	COMPONENT DESCRIPTION	PART No.	CHECK	QTY	COMPONENT DESCRIPTION	PART No.	CHECK
<b>2</b>	 CHANNEL L = 2300mm	<b>C2300</b>		<b>10</b>	 CHANNEL L = 285mm	<b>K0285</b>	
<b>2</b>	 CHANNEL L = 2070mm	<b>N2070</b>		<b>2</b>	 CHANNEL L = 240mm	<b>C0240</b>	
<b>2</b>	 CHANNEL L = 2034mm	<b>C2034</b>		<b>2</b>	 CHANNEL L = 100mm	<b>C0100</b>	
<b>2</b>	 CHANNEL L = 1484mm	<b>M1484</b>		<b>1</b>	 HAT = 2290mm	<b>99A</b>	
<b>4</b>	 HAT = 1350mm	<b>99B</b>		<b>1</b>	HIGH-FRONT FRAME FITTINGS PACK (SEE BELOW)		
HIGH-FRONT FRAME FITTINGS PACK CONTENTS							
<b>10</b>	 MULTI PURPOSE BRACKET			<b>1</b>	 SMALL TRIANGULAR PLATE		
<b>6</b>	 10mm DYNABOLTS			<b>150</b>	 SELF DRILLING 16mm TEK SCREWS		



## Guide on Splitting Sheets

- This product comes with a perforated sheet that is designed to be split into two smaller sheets.
- **These sheets have sharp edges. Once separated please use appropriate foot and hand protection when handling.**
- In order to split the sheet lay it on the ground and lift and fold one end until the perforations have cleanly snapped.
- Discard the middle piece as scrap when convenient. Fold the scrap piece in half two or three times and throw in garbage.

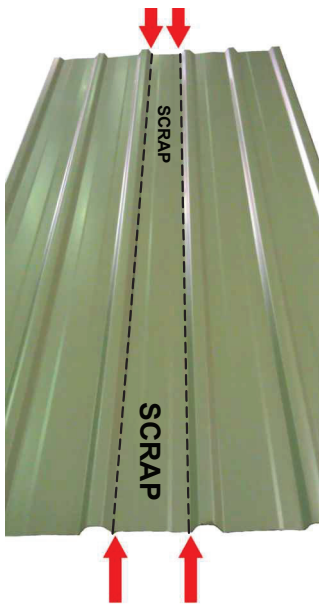

Check sheet for perforations





Fold first side of sheet until free



Fold middle section of sheet until free



Discard middle piece

SPLITTING SHEET H39						
QTY	COMPONENT DESCRIPTION	PART No.		QTY	COMPONENT DESCRIPTION	PART No.
1	 STEEL SHEET 2034mm X 773mm	H39	=	2	 STEEL SHEET 2034mm X 329mm	H39B

## SNAPTITE ASSEMBLY GUIDE

The Snaptite Assembly System locks end channels to all roof and wall sheets without the need for tools and fasteners.

To assemble each panel, the perimeter channels are secured to the top and bottom of each panel. Gently tap the channel over the SNAPTITE lugs on the sheet, working along the sheet.

Each perimeter channel must finish flush with the edges of the sheets. Simply tap the channel along the sheets until each end is neatly flush. If you need to remove channels from the panels, slide it off from the side.

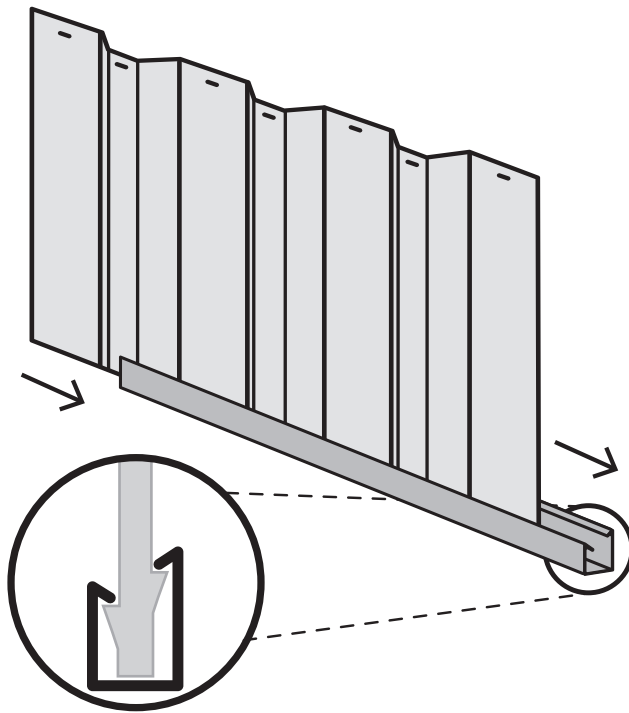

**SNAPTITE**  
World's Easiest Assembly System  
*UNIQUE PATENTED SYSTEM*

Channel locks the shed panel into position without the need for screws!

### FASTENING SYMBOLS

**SNAPTITE**

Secure channel to sheeting by SNAPTITE fastening method.



Join components together with one screw at this location only, as some channels have extra holes that are not required for this model of shed.

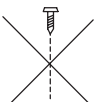

Do not join components together at this location yet, as the screws may obstruct further assembly of the other components.



Join components together by pre-drilling the holes first. Use one component as template to mark where the holes are and drill with a 3mm drill bit.



3mm pop rivet



4mm nut and bolt set.

### Guide on Joining Spliced Channels

The text marked on all parts must be shown on the same side as each other



**Step 1.**  
Position the channels and the CSJ joiner so the centre of the CSJ is in line with the end of each channel to be joined together.

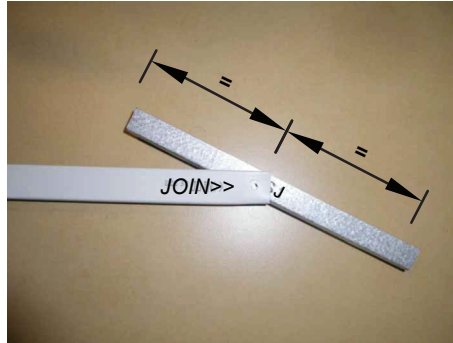

**Step 2.**  
Join the first channel to the CSJ by inserting the centre of the CSJ, on an angle, to the end of the channel where the JOIN>> text is marked.

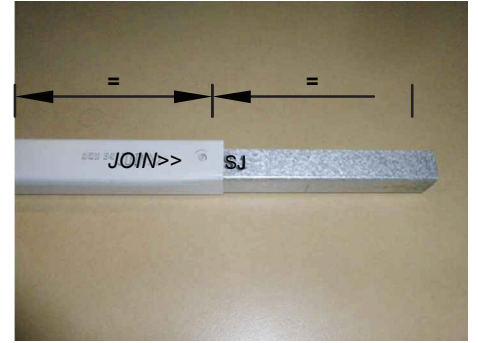

Push down one side of the CSJ until you hear a 'click'.

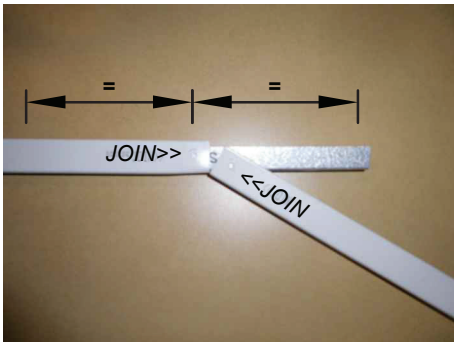

**Step 3.**  
Join the second channel to the CSJ by positioning the <<JOIN of the channel at the centre of the CSJ, on an angle. Push the CSJ into the channel until you hear a 'click'.

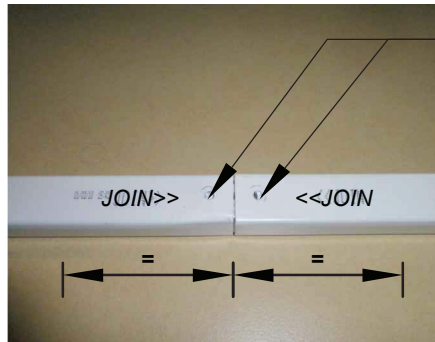

**Finished Channel.**  
The joined channels should now look like the picture with the CSJ positioned equally inside of the joined channels.

Drill out holes with 3mm drill bit in CSJ to match the holes in channel. Drilling of screws on the joined channels is being done after sheets are locked on the spliced channels.

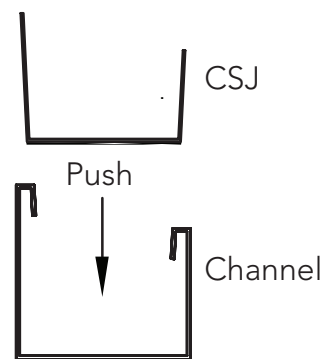

...

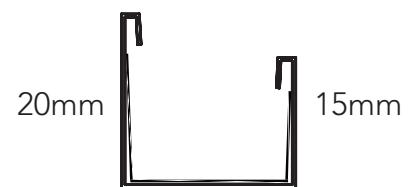

Finished Spliced Channel

## PRE-ASSEMBLY OF SPLICED CHANNELS

Join together 38 x channel sections using 19 x channel joiners (Part CSJ)

NOTE: Some channels may have holes in them - You will need to redrill holes where CSJ joining channel covers them.

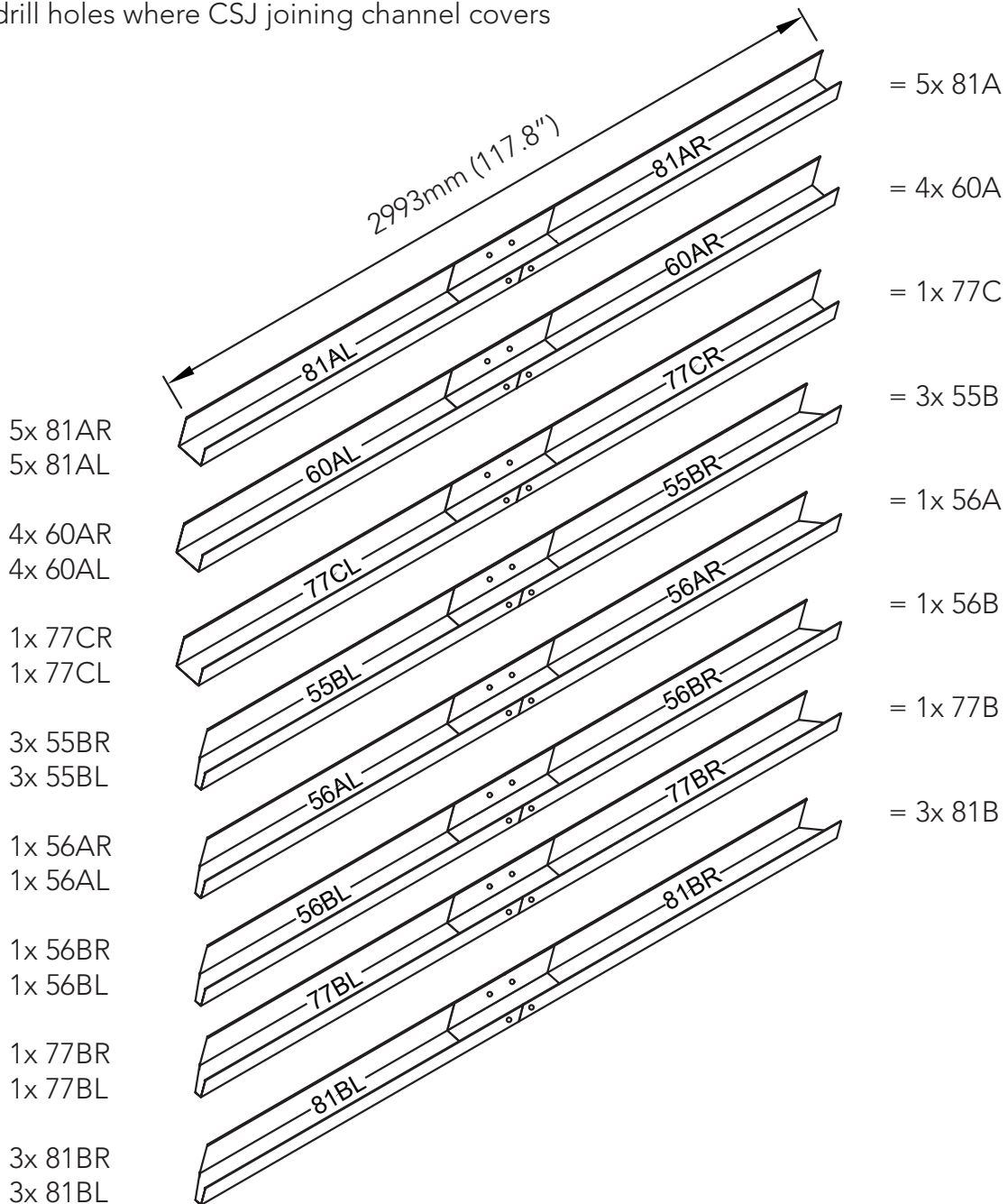

## Guide on Joining a Spliced Ridge Beam

Follow these three steps to assemble a ridge beam.

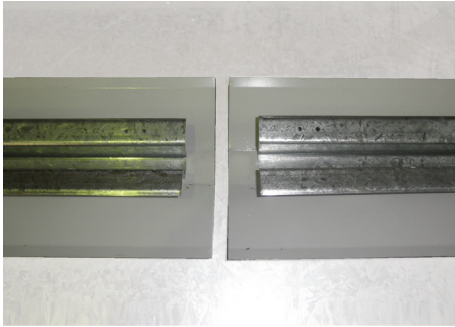

**Step 1.**  
Place two ridge beams as shown and push them together. Slide the cap of one under the other.

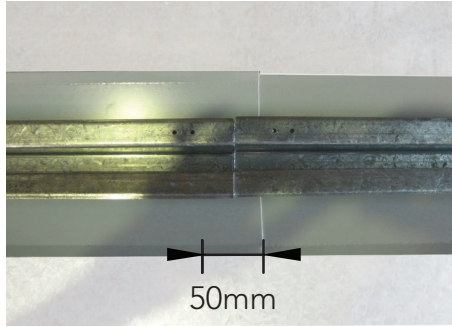

**NOTE.**  
There is a 50mm overlap of the ridge caps when the beams are in position.

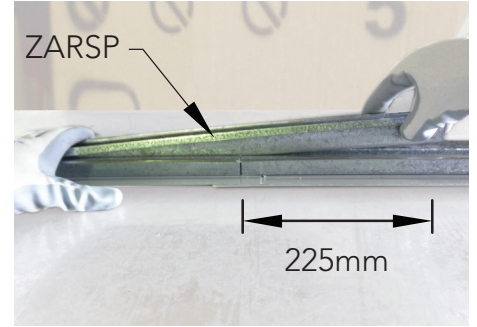

**Step 2.**  
Use the ZARSP to connect at the centre of the two ridge beams. Be sure it is pushed in fully.



**Step 3.**  
Turn over the ridge beam. Measure 250mm from the middle along the centre of one ridge beam, mark spacings of 50mm. Fasten with a Tek screw at each marking.



Repeat to the other side of the ridge beam assembly.

**TIP:** Pre-drilling each hole with the 3mm drill bit makes it easier to fasten.

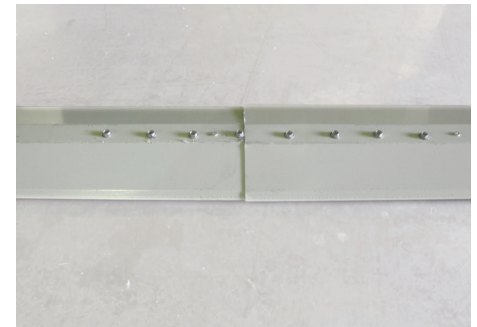

Finished Spliced Ridge Beam



Hex Driver Bit



Hex Hd Self-drilling tek screw with neoprene washer

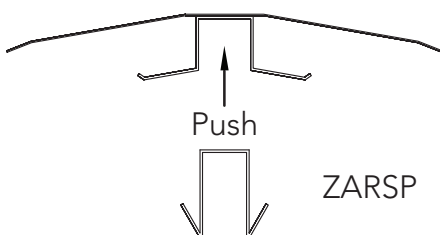

ZARSP

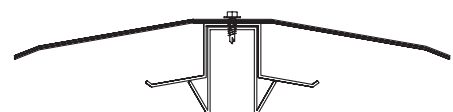

Finished  
Joined Ridge Beams

**PRE-ASSEMBLY OF SPLICED RIDGE BEAM**

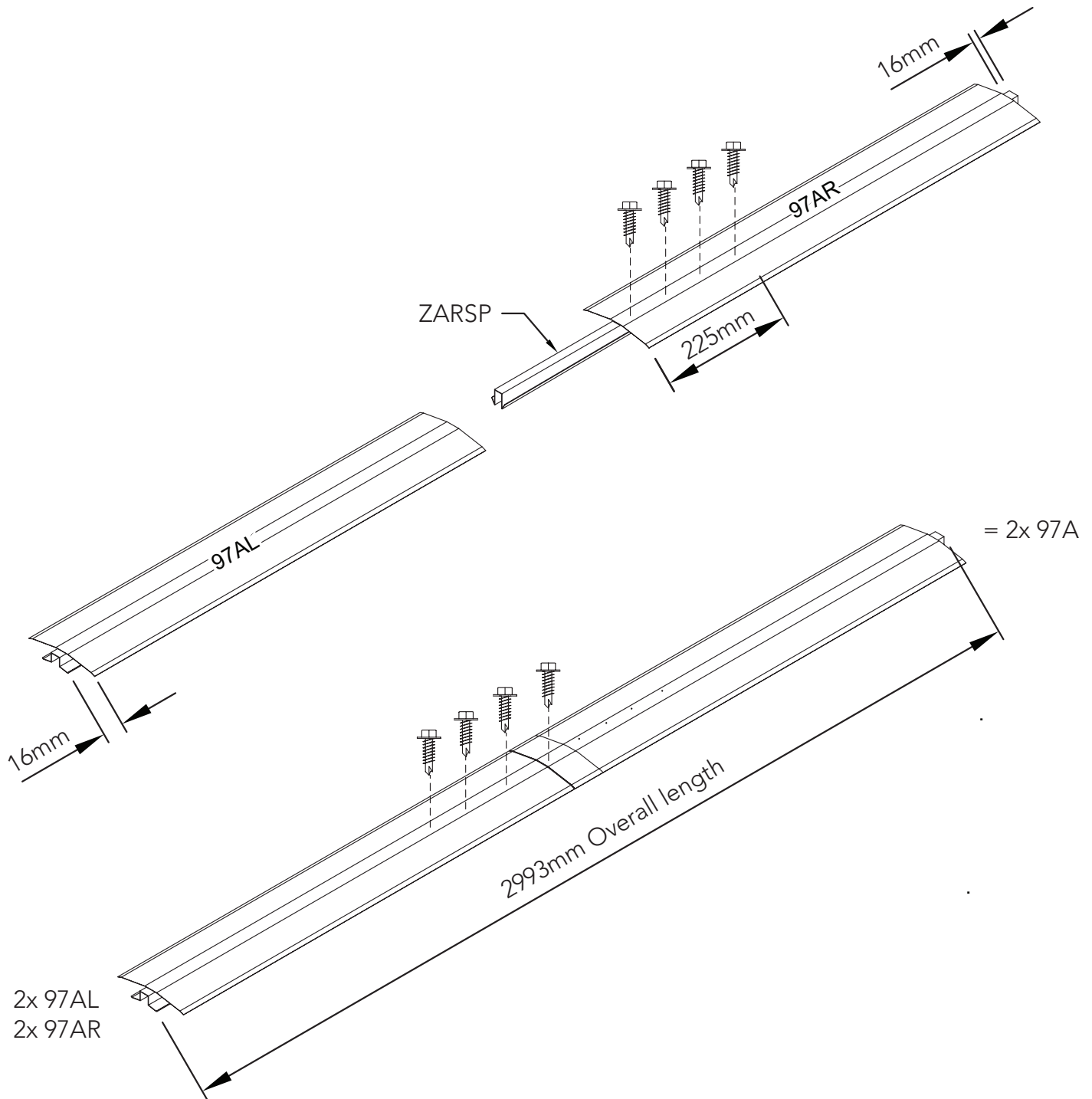

## JOINING RIDGE BEAMS

To make the total span we must now join the two ridge beams

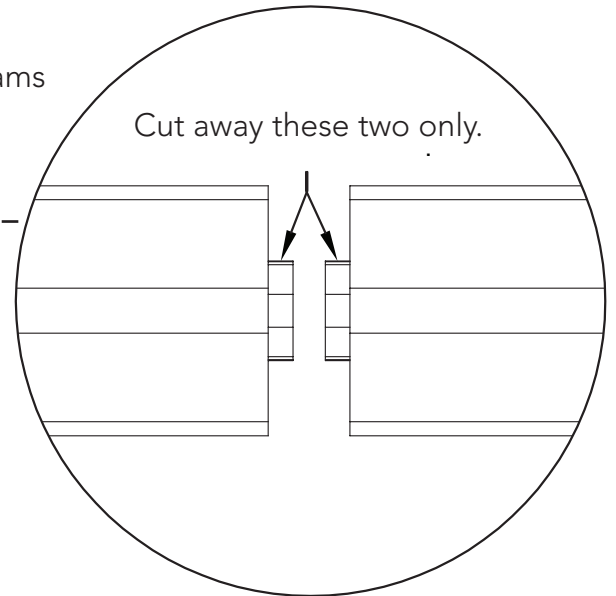
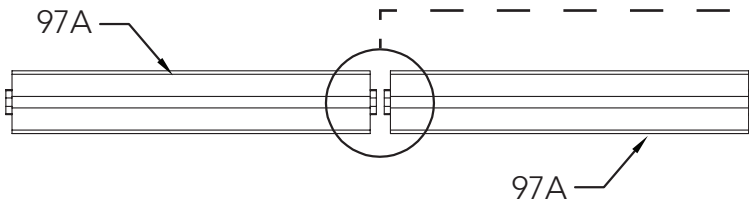

Using a hacksaw, remove one protruding section of each ridge beam, this will allow the sections to butt up neatly to each other.

Insert the ZARSP at an equal distance into each ridge beam. Confirm that the beam is straight with a string line before fastening with self drilling screws.

The ZARSP is a very tight fit, tap into place with a hammer.

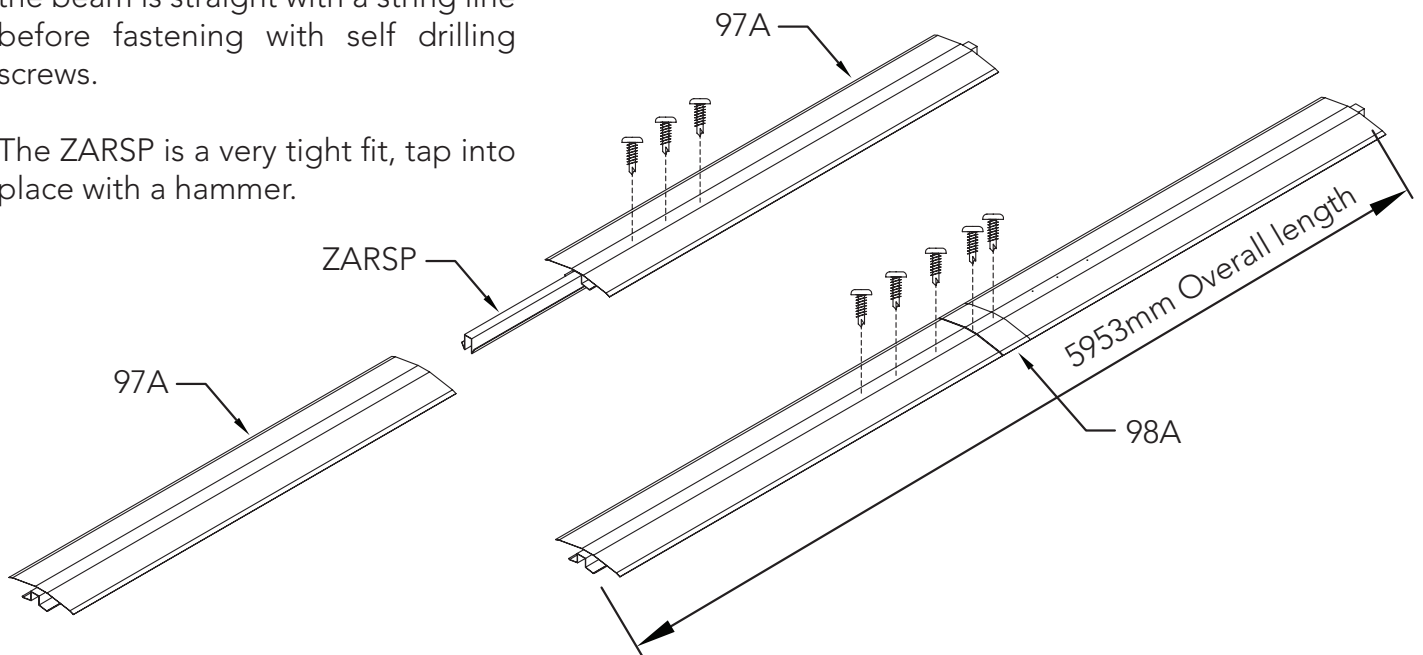

Hex Driver Bit



Hex Hd Self-drilling tek screw  
with neoprene washer

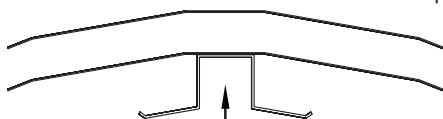

98A

97A

Push

ZARSP



Finished  
Joined Ridge Beams

**OVERVIEW OF ROOF COMPONENTS**

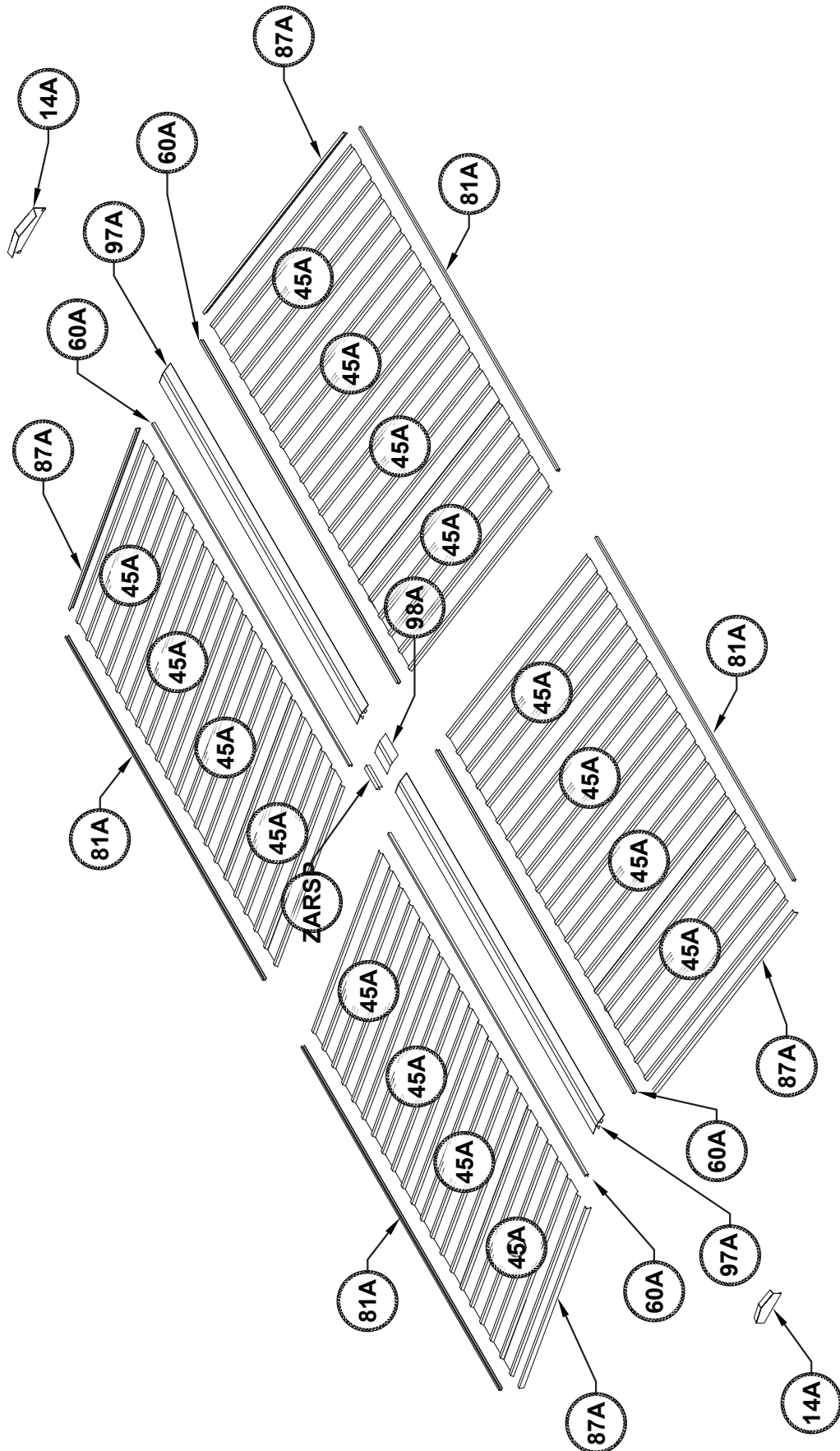

OVERVIEW OF ROOF COMPONENTS



## OVERVIEW OF WALL COMPONENTS

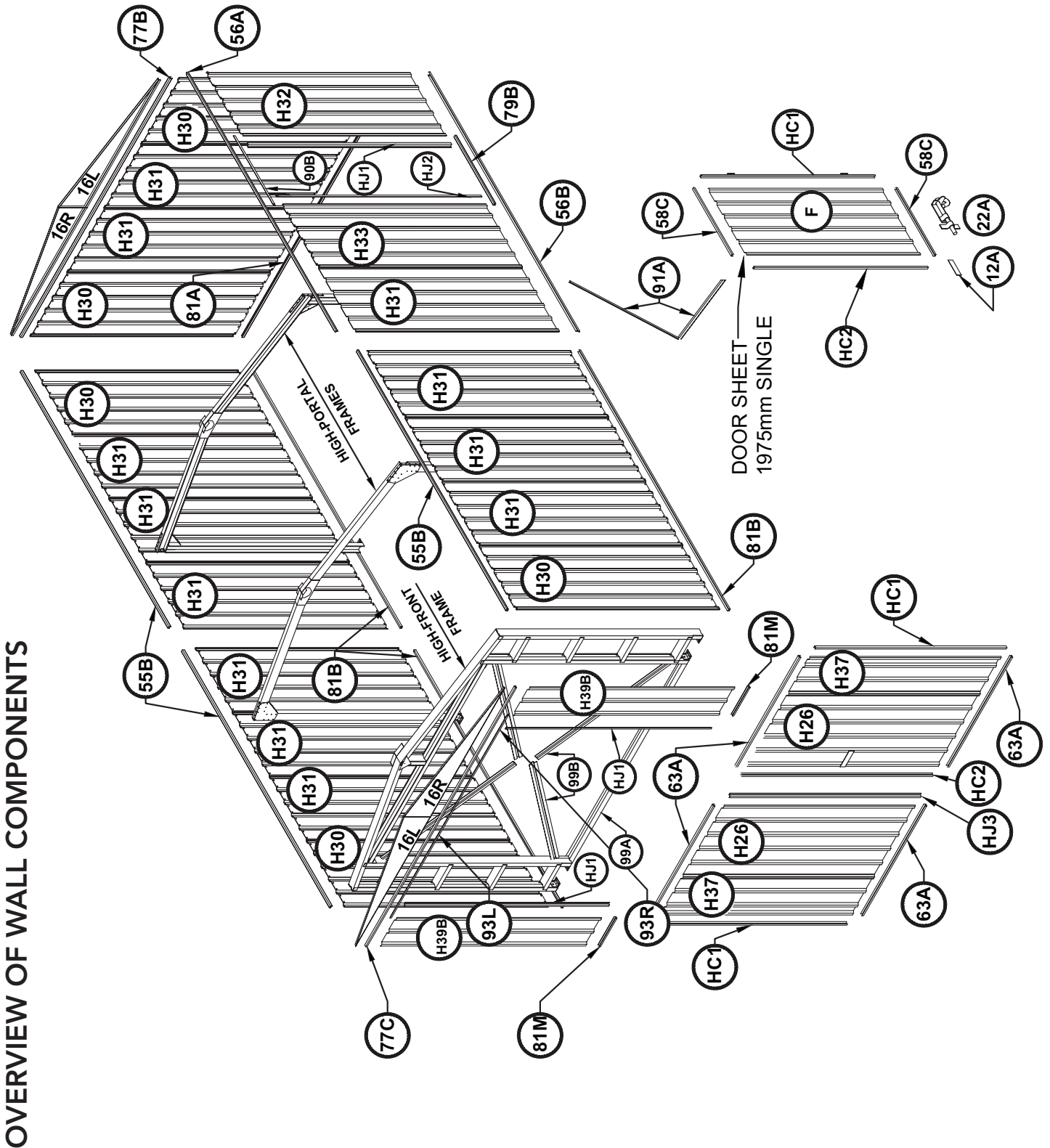

OVERVIEW OF WALL COMPONENTS

## SIDE PANEL ASSEMBLY

3 required.

One panel requires sheet H30 this end.

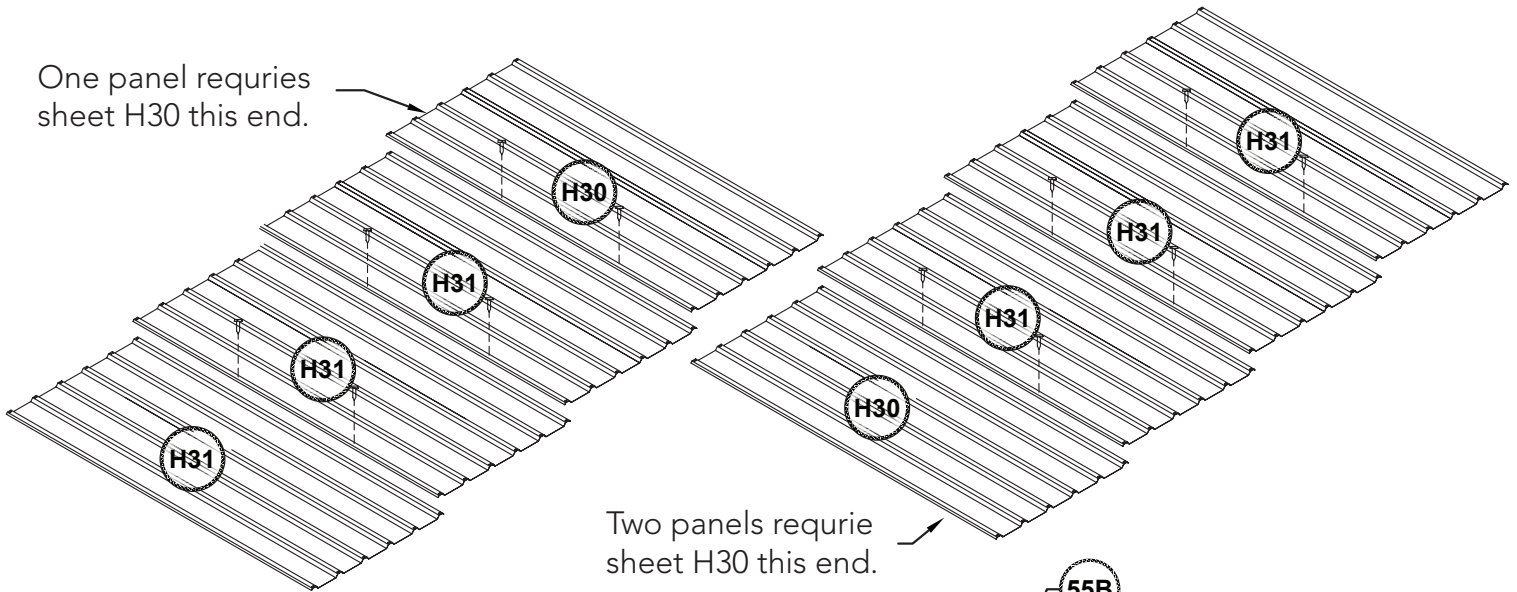

Two panels require sheet H30 this end.

H30 is a corner sheet and must be orientated towards the shed corners when panels finally joined.

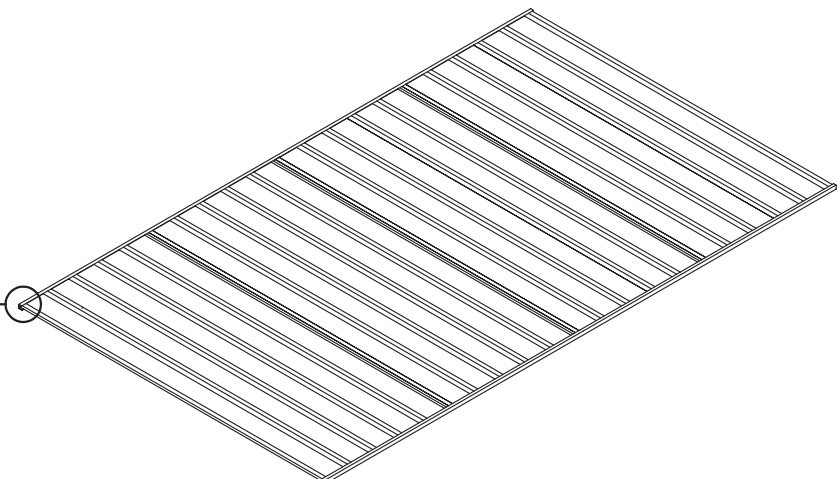
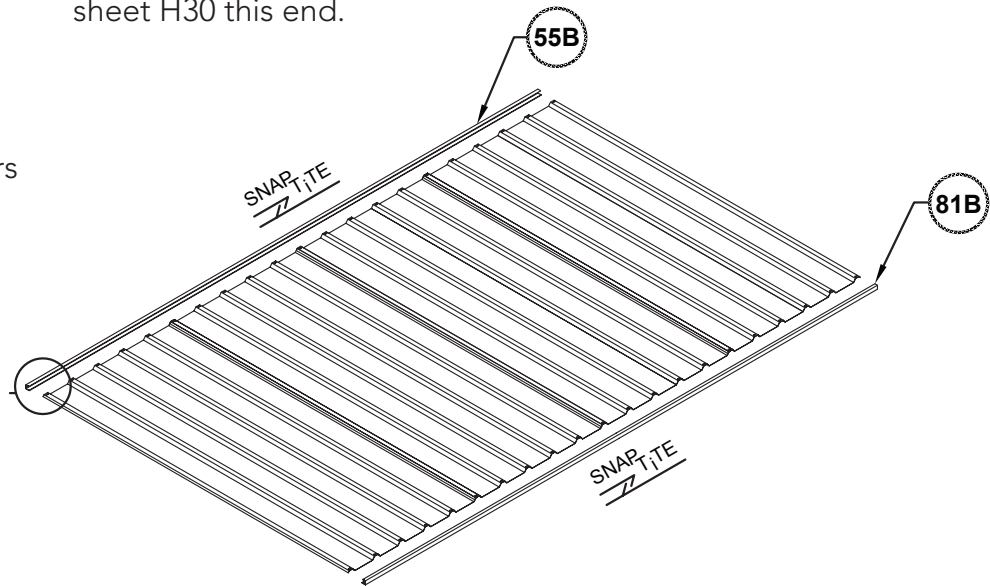
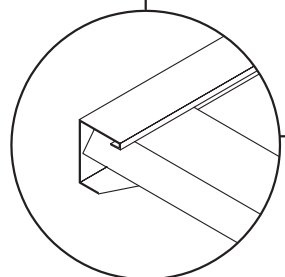
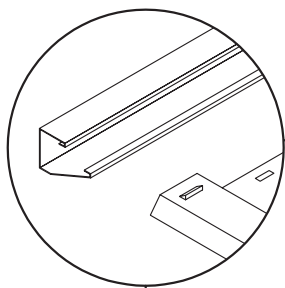

## ROOF PANEL ASSEMBLY

4 required.

When completed there will be four sections with 87A lip at one end only.

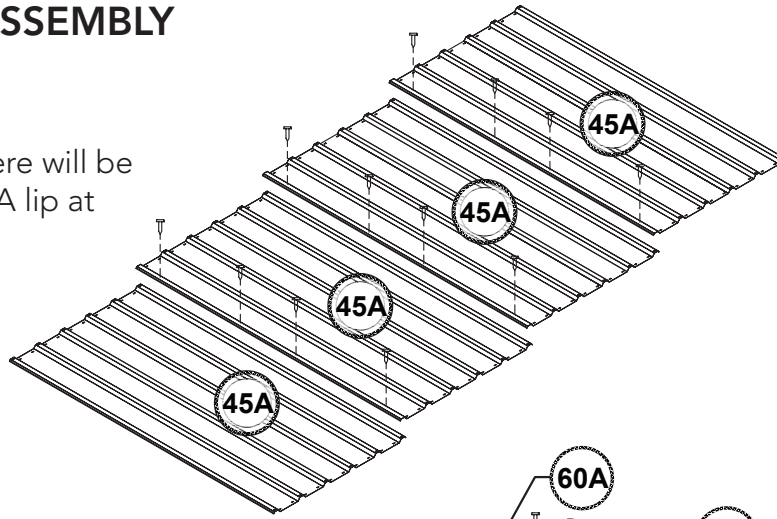

Two panels will have part 87A fitted to this end only.

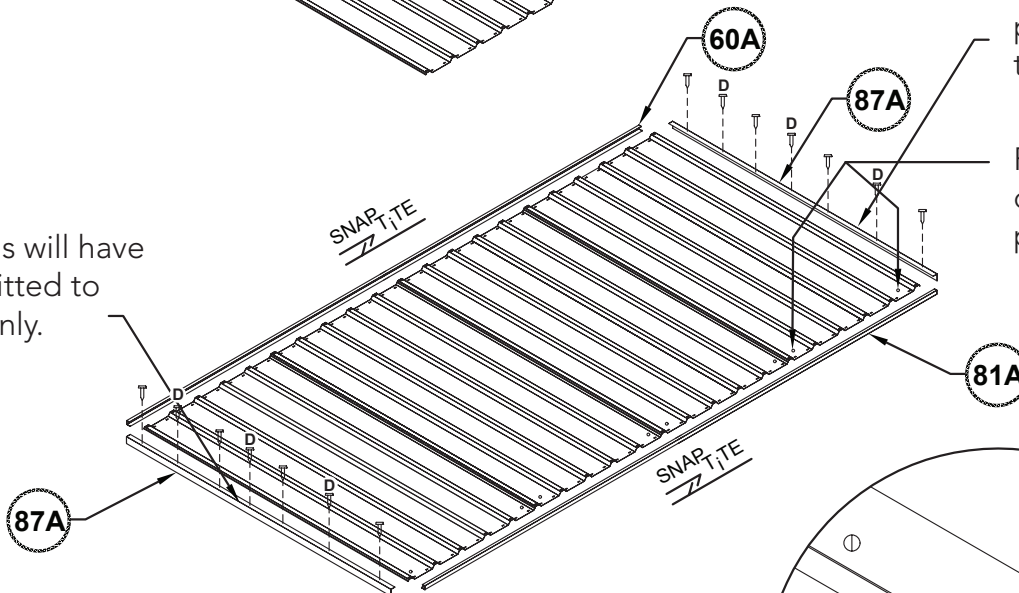

Two panels will have part 87A fitted to this end only.

Fit 81A to edge of sheet with pre-punched holes.

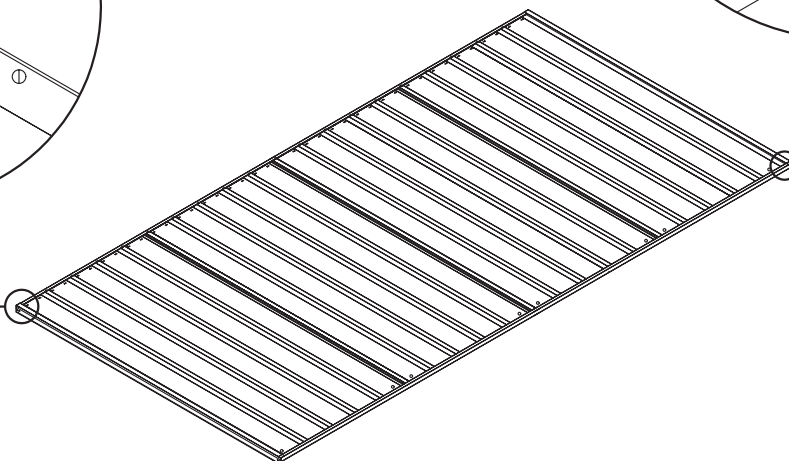
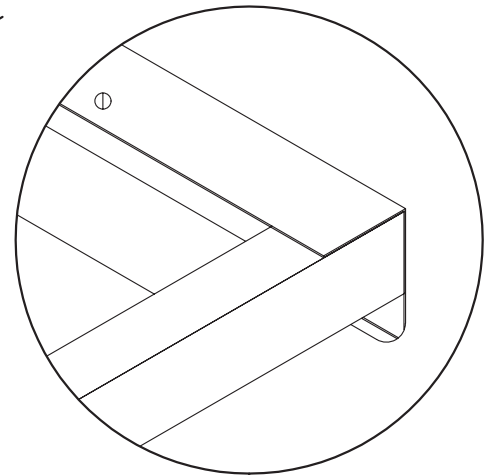
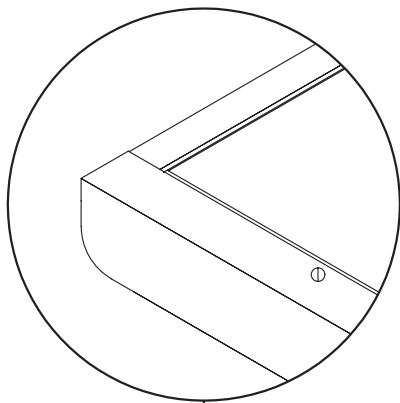

## JOINING WALL AND ROOF PANELS

To make the total span we must now join sections of sheeting together for the roof and wall.

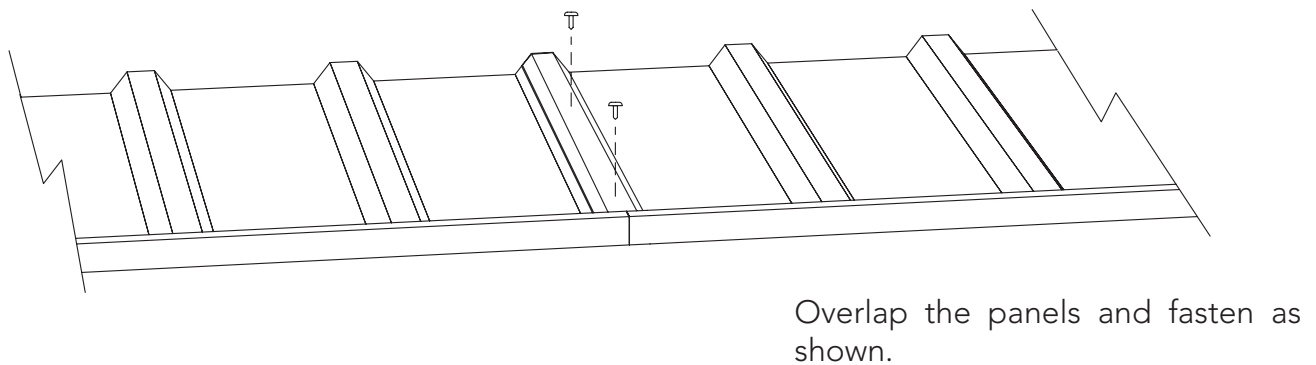
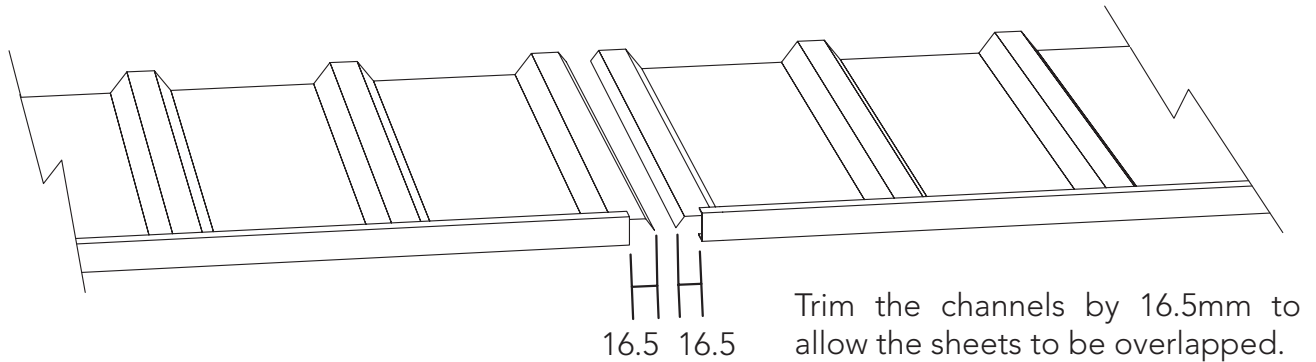

Refer to the panel construction section of this instruction set for further details and ensure that the assembled panels are not joined together with pre-punched holes incorrectly positioned.

The overall length of each panel is the same as the ridge beam.

Ridge beam and panel length	= 2993mm
Length to be cut off	= 16.5mm
New length	= 2976.5mm

Both panels joined =  $2976.5 \times 2 = 5953\text{mm}$

It is not critical that the overall dimension is exact but try and make sure the length is within 5mm.

### END PANEL ASSEMBLY

1 required.

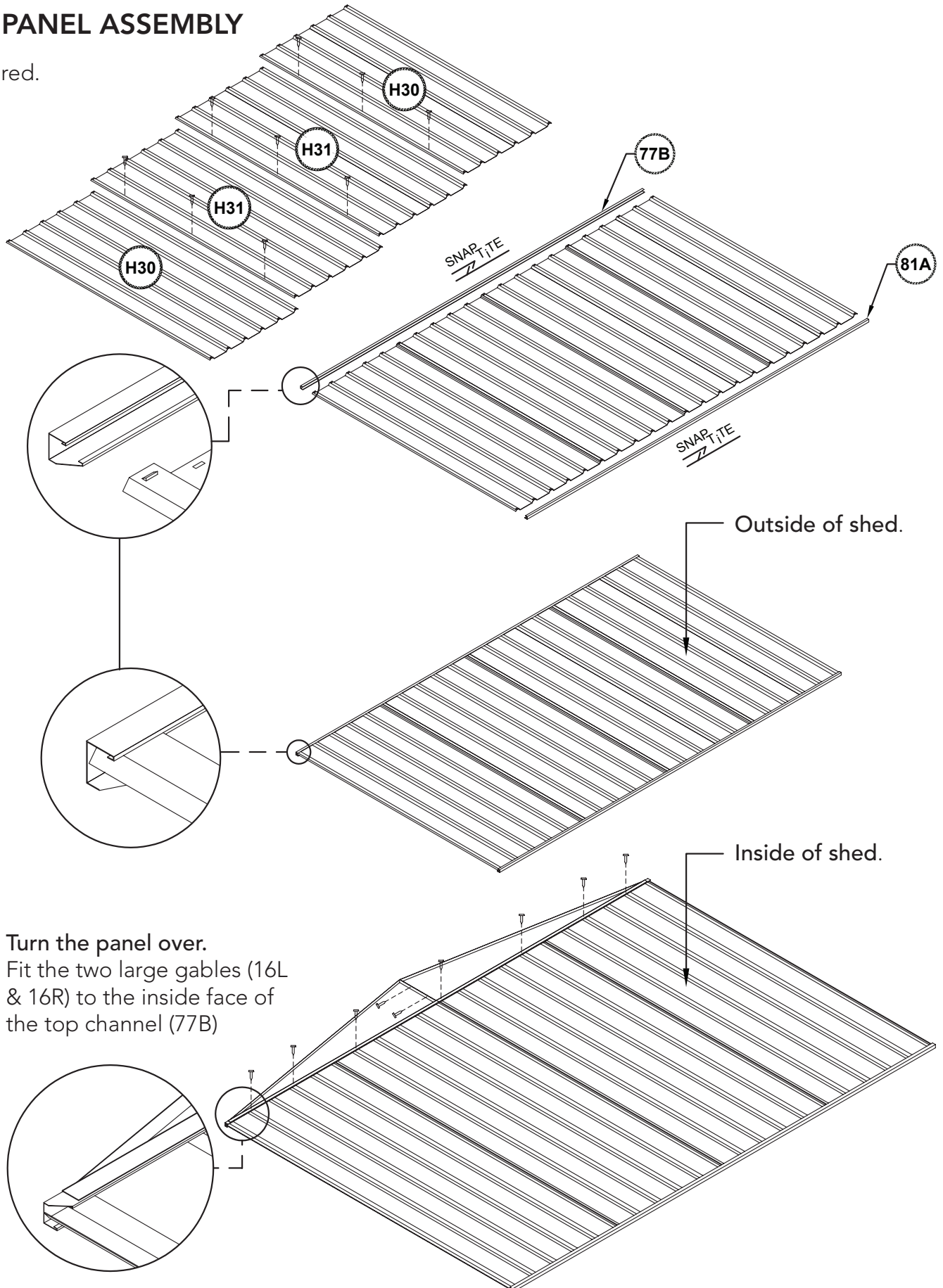

### DOOR PANEL ASSEMBLY DOUBLE DOOR

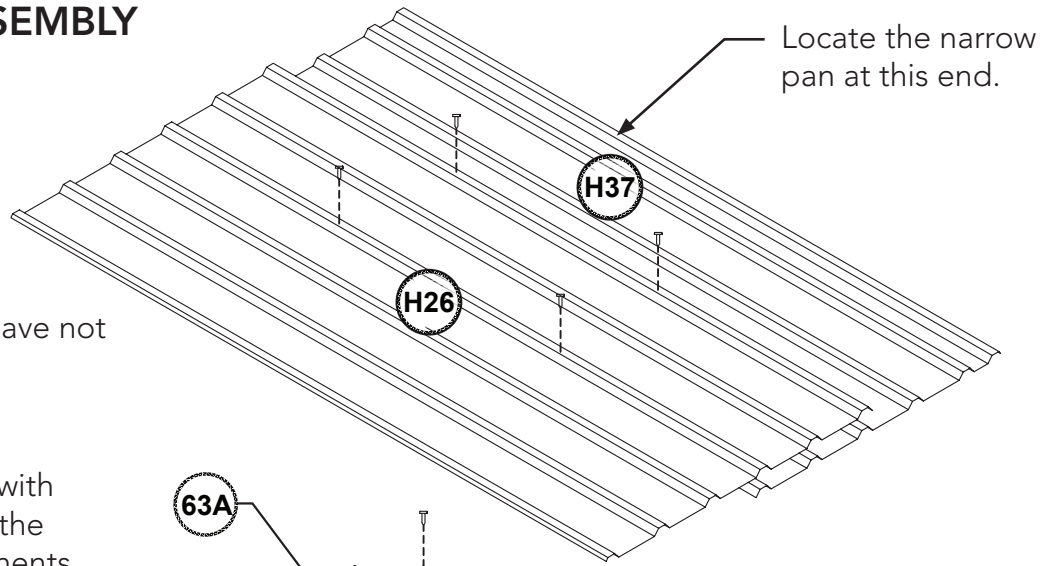

Note: These sheets have not been pre-punched.

Pre-drill door sheets with a 3mm drill bit using the pre-punched components shown as templates

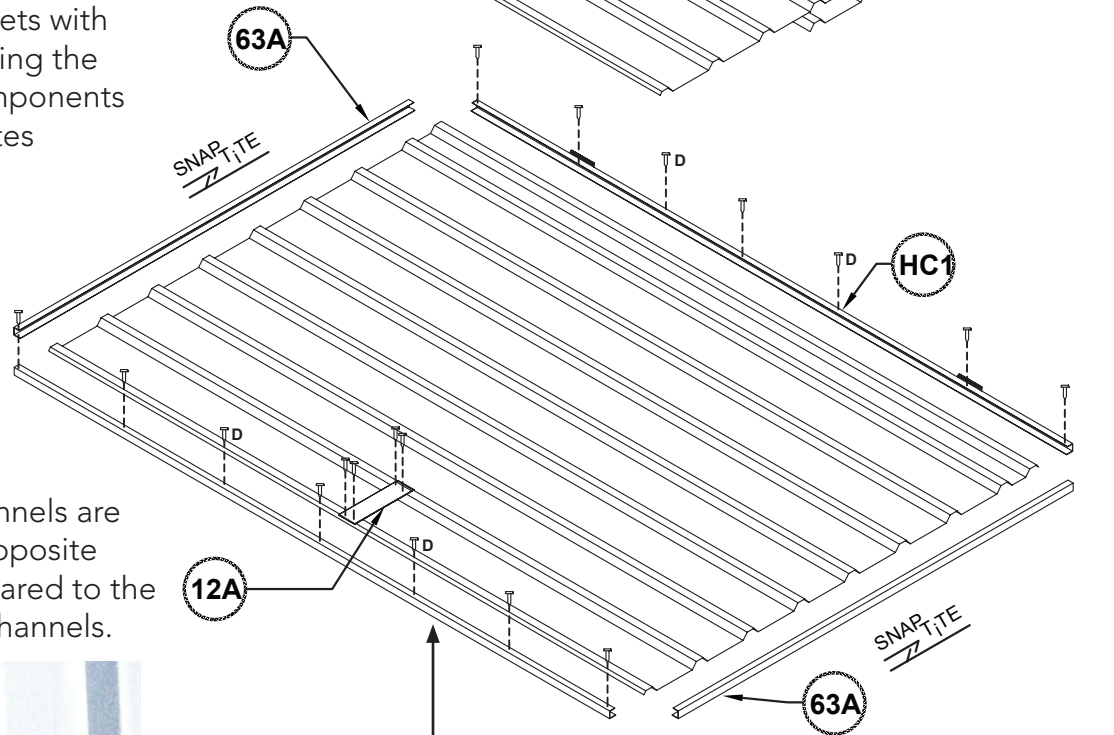

Vertical door channels are installed in the opposite orientation compared to the horizontal door channels.

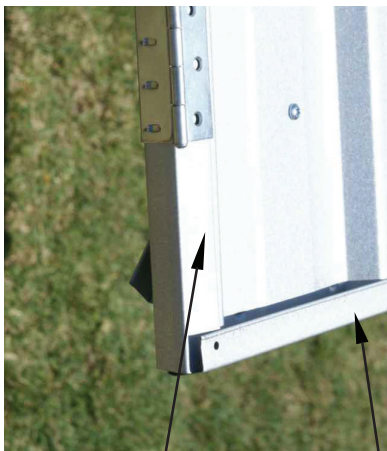

Long flange of channel

Short flange of channel

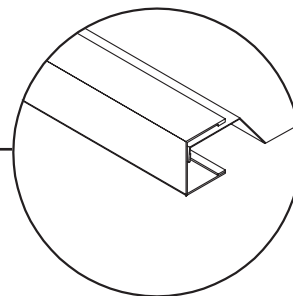
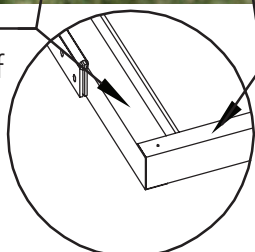

Fit one door with a channel (HC2)

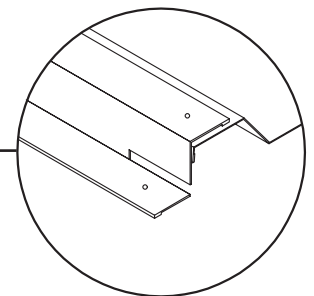

Fit the other with a jamb (HJ3)

**DOOR PANEL ASSEMBLY**  
**SINGLE DOOR**

1 required.

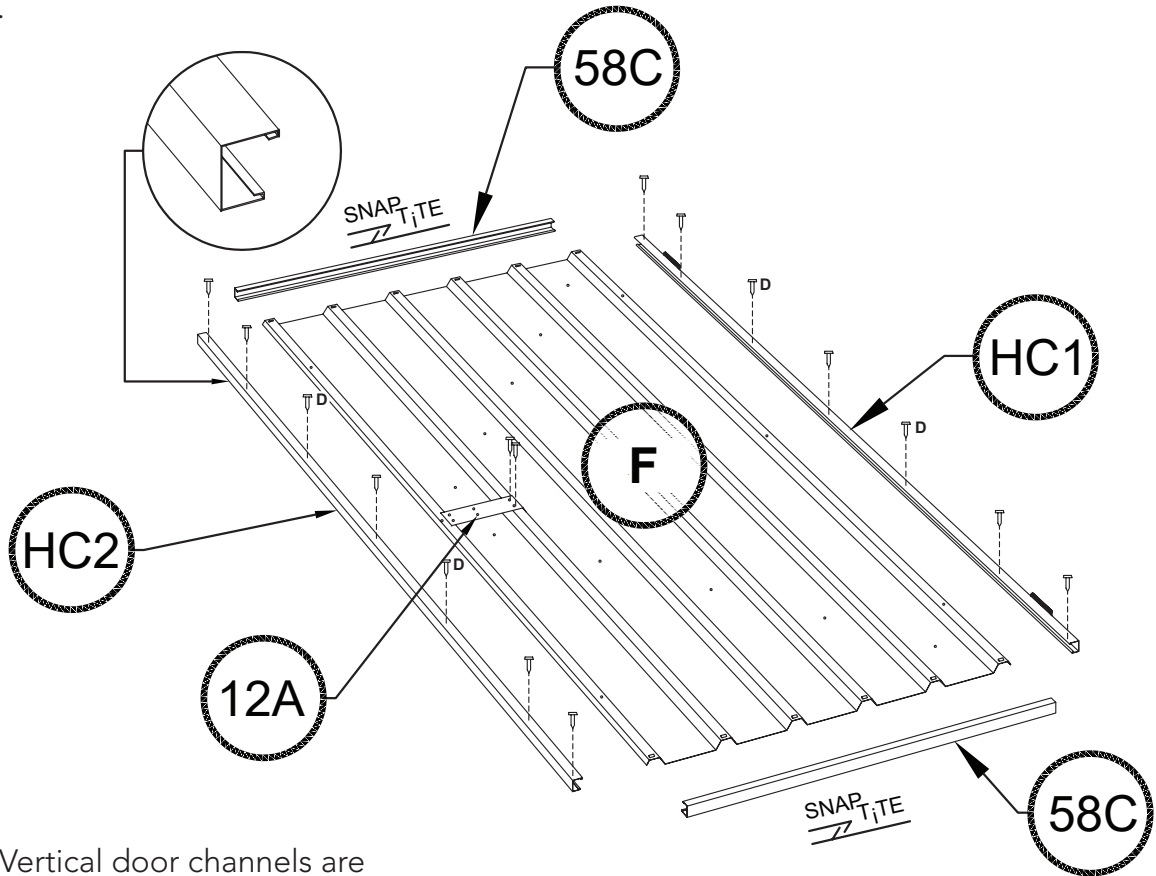

Vertical door channels are installed in the opposite orientation compared to the horizontal door channels.

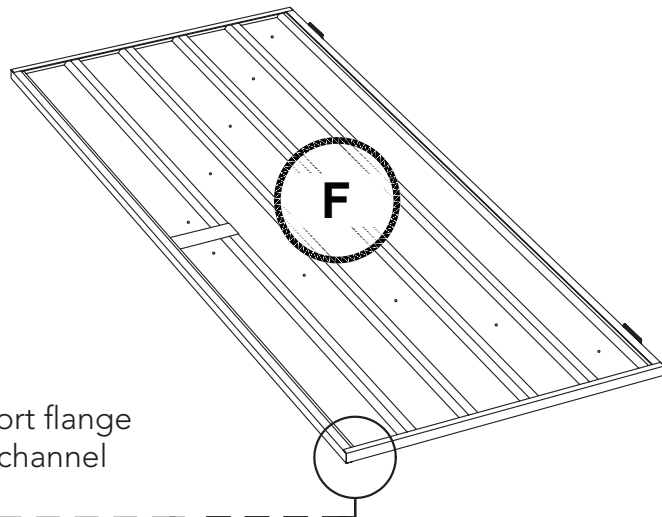
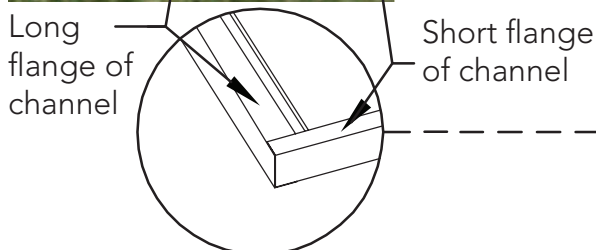
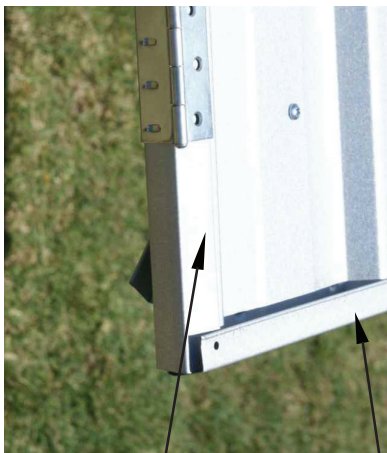

## SIDE PANEL ASSEMBLY

### SINGLE DOOR PANEL

1 required.

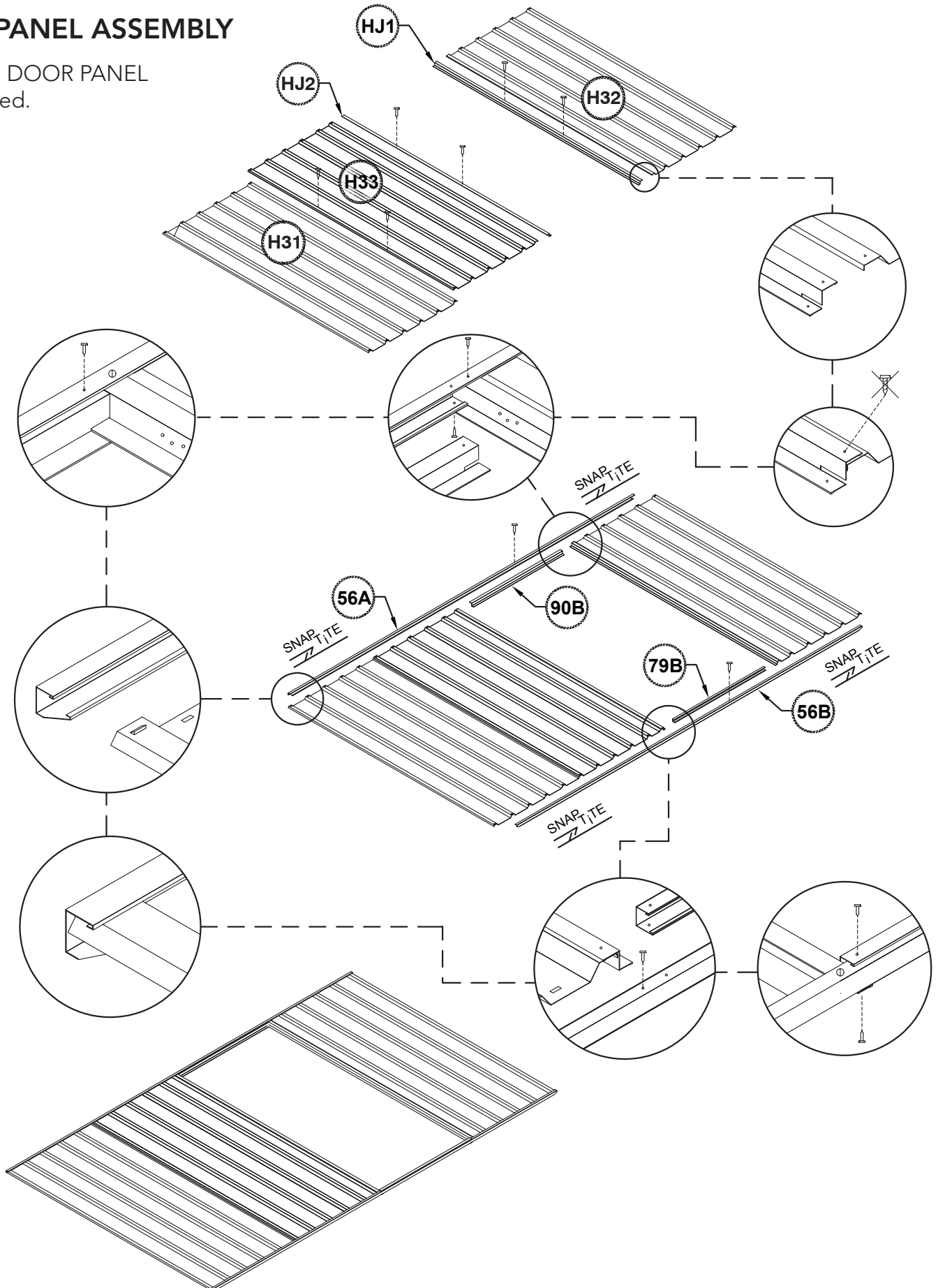



### DOOR PANEL ASSEMBLY

#### SINGLE DOOR PANEL

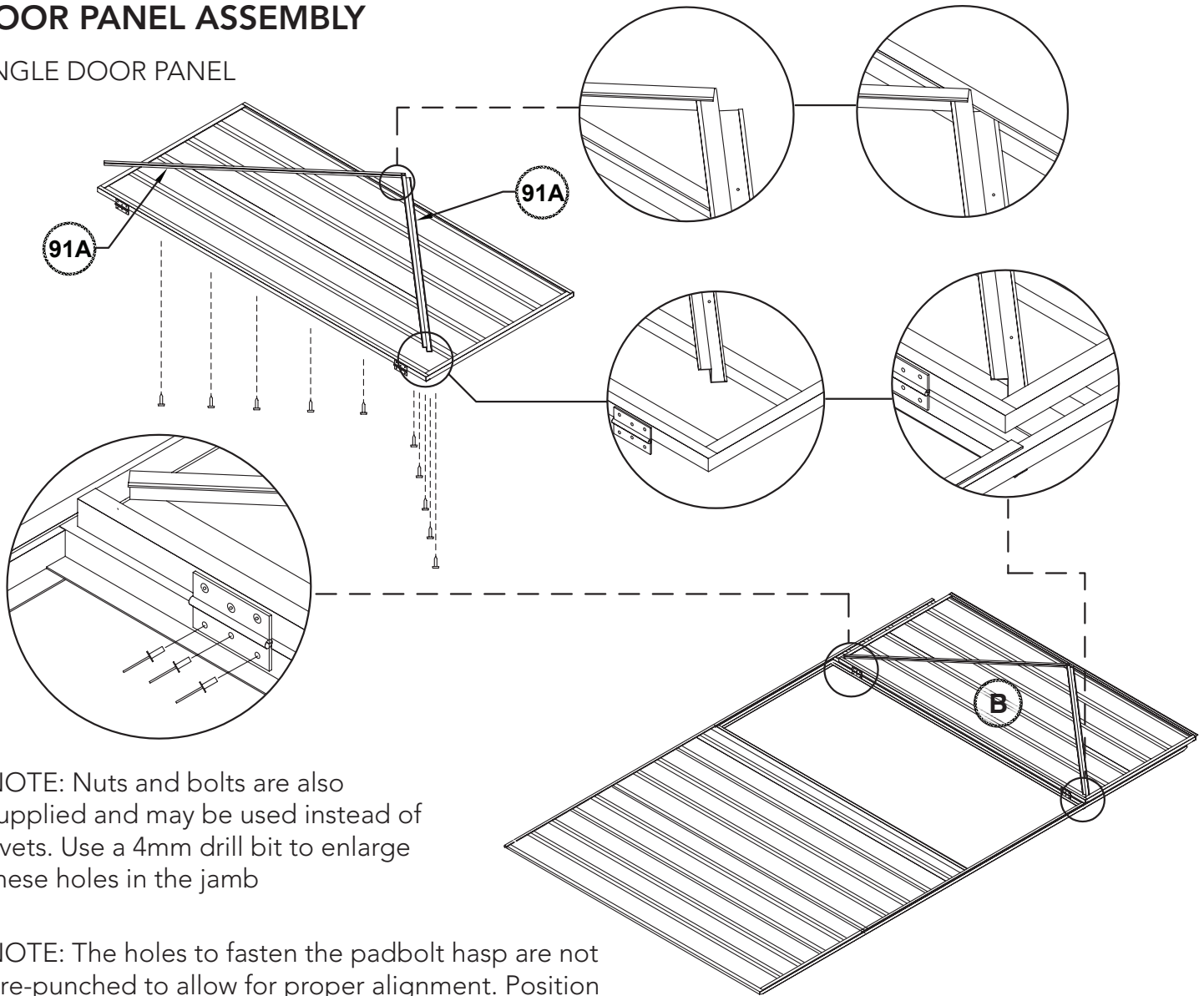

NOTE: Nuts and bolts are also supplied and may be used instead of rivets. Use a 4mm drill bit to enlarge these holes in the jamb

NOTE: The holes to fasten the padbolt hasp are not pre-punched to allow for proper alignment. Position the hasp centrally over the padbolt shaft and drill 3mm holes and secure with screws.

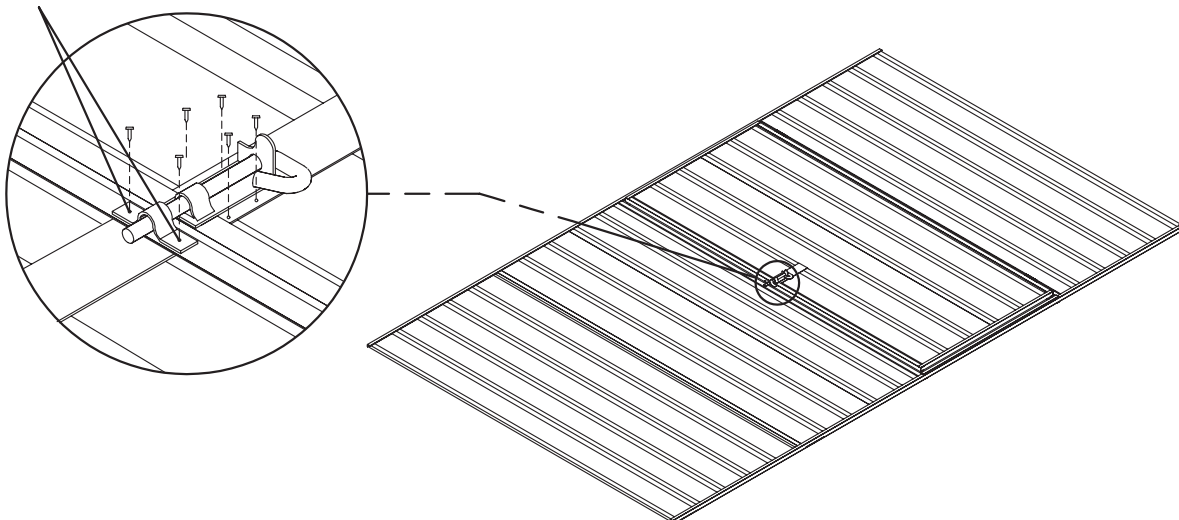

## HIGH PORTAL FRAME DETAILS

2 required.

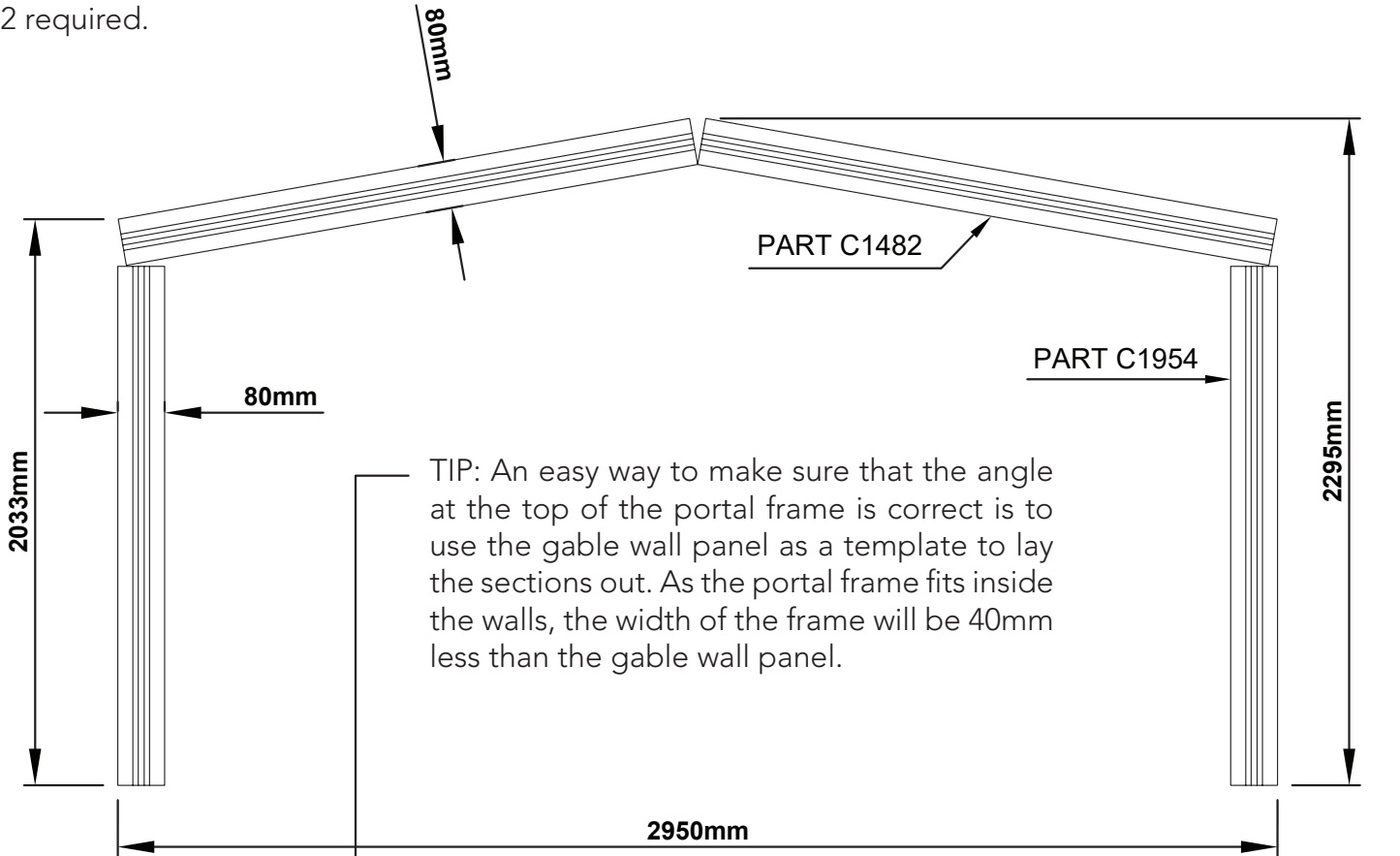

NOTE: Refer to the section HIGH CENTRE PORTAL ASSEMBLY for photos of the process.

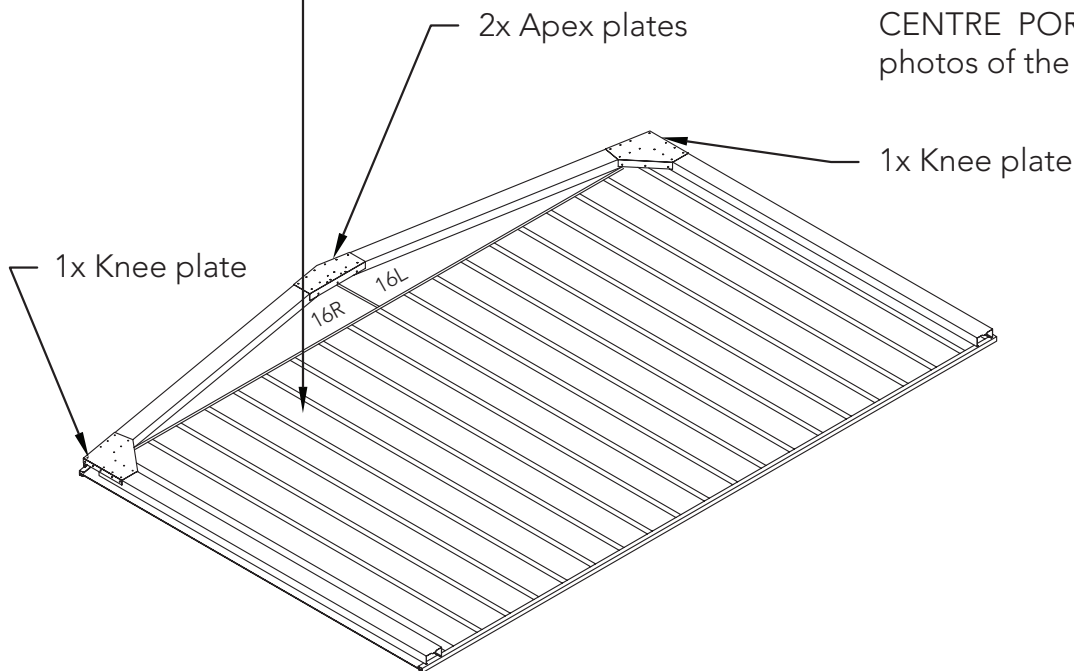

NOTE: If you have a slab with an edge rebate in your concrete slab, you will have to cut an amount off the bottom of the frame legs equal to the depth of the rebate.

## HIGH PORTAL FRAME ASSEMBLY

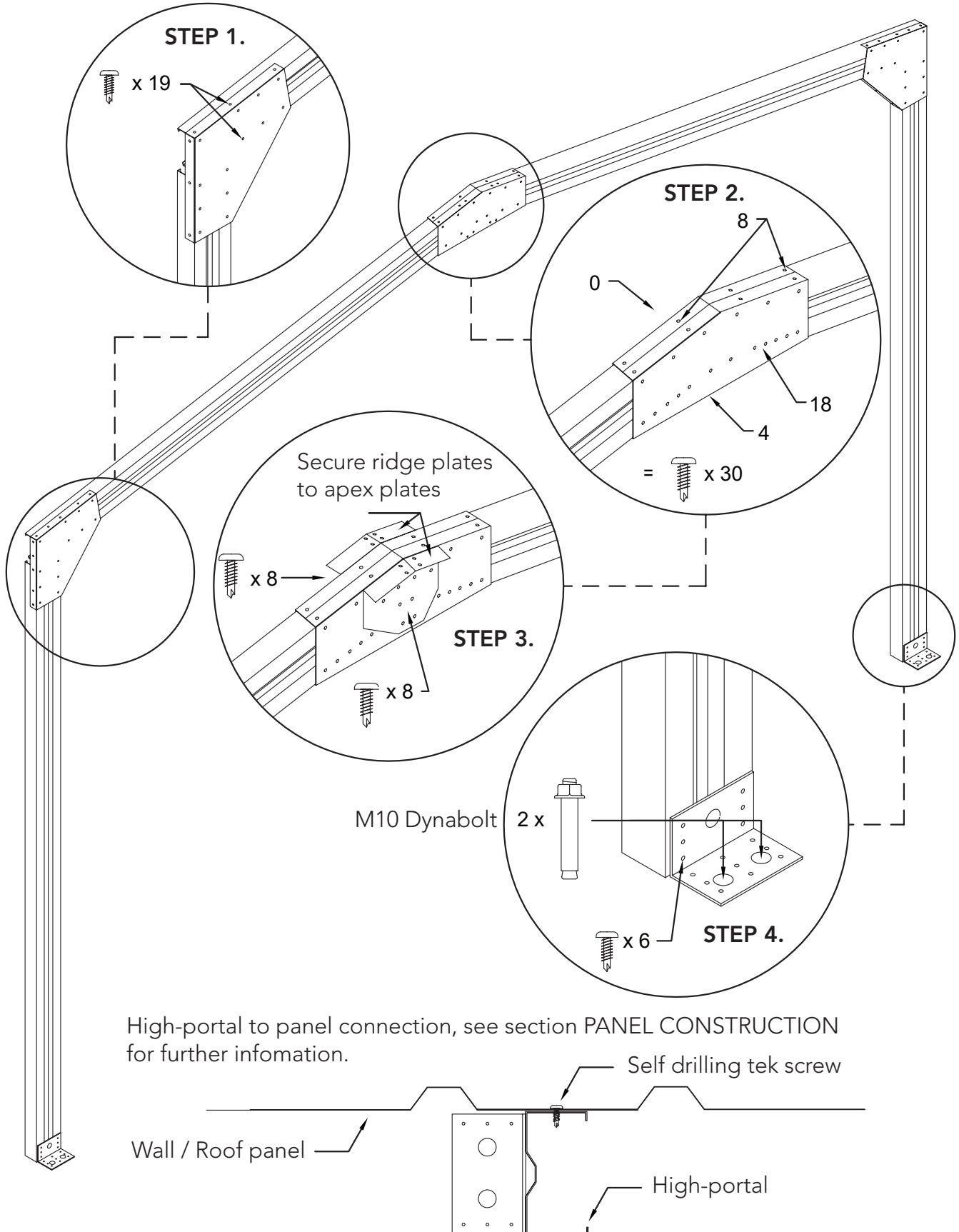

## HIGH CENTRE PORTAL ASSEMBLY SUPPORT PHOTOS

### STEP 1.

Draw pattern on the concrete in accordance with the dimensions detailed in the assembly instructions.

#### Step 1a

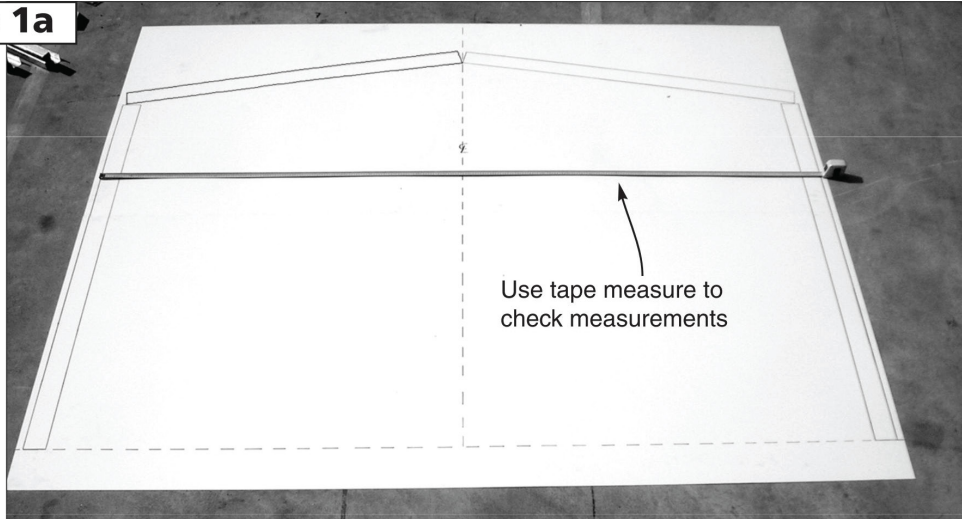

#### Step 1b

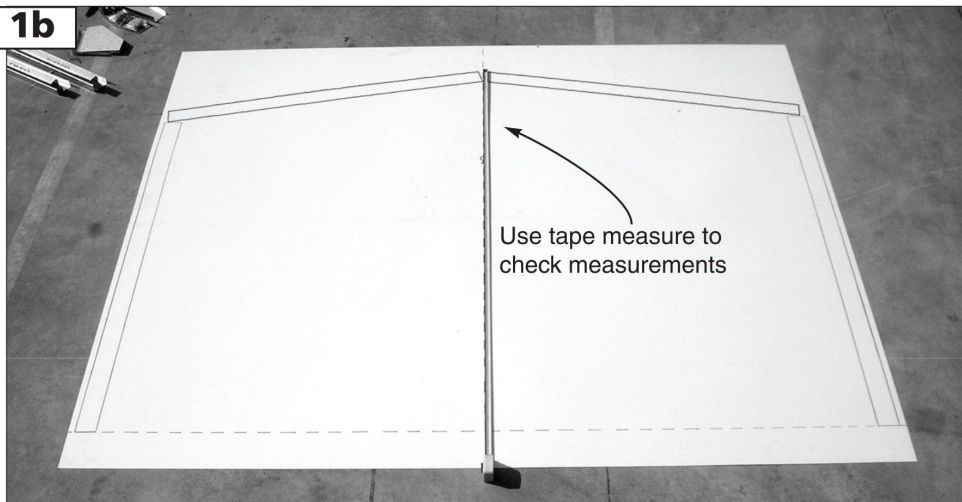

#### Step 1c

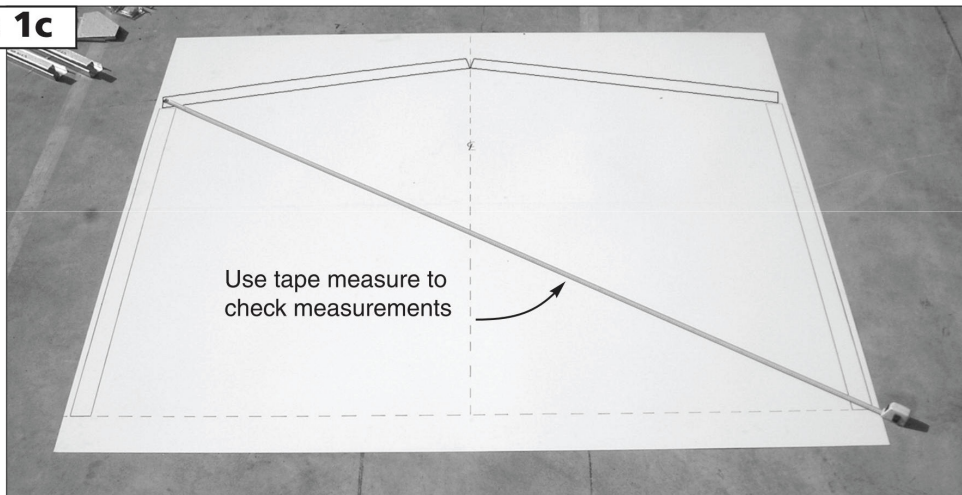

## HIGH CENTRE PORTAL ASSEMBLY SUPPORT PHOTOS

### STEP 2.

Understand where components are to be positioned

#### Step 2a

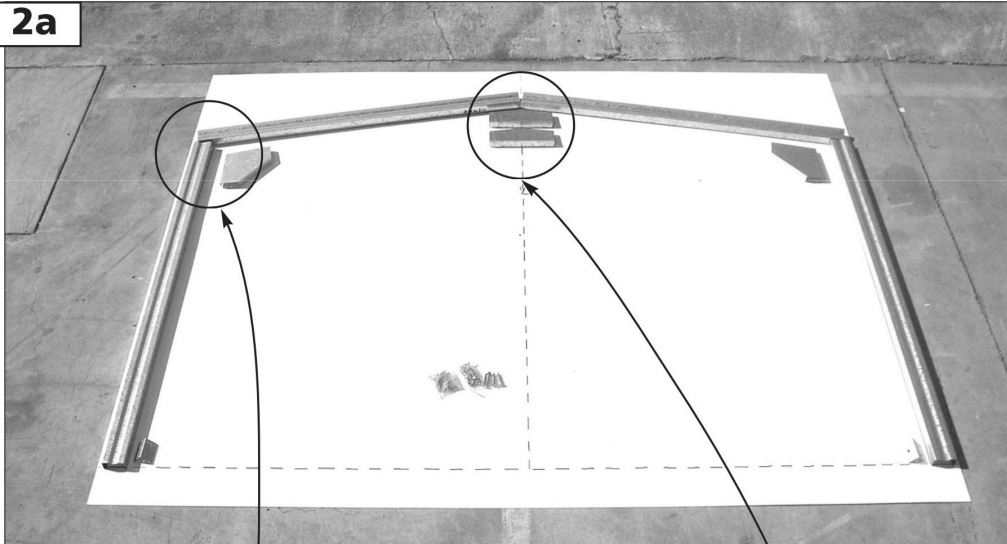

#### Step 2b

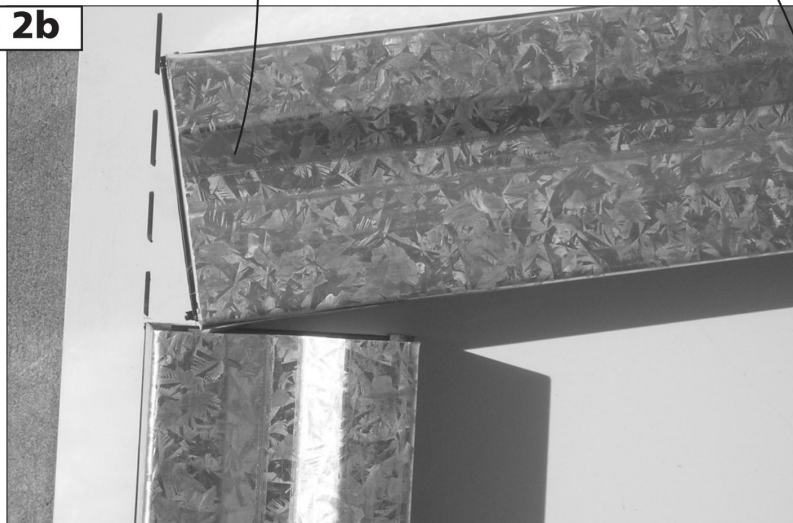

#### Step

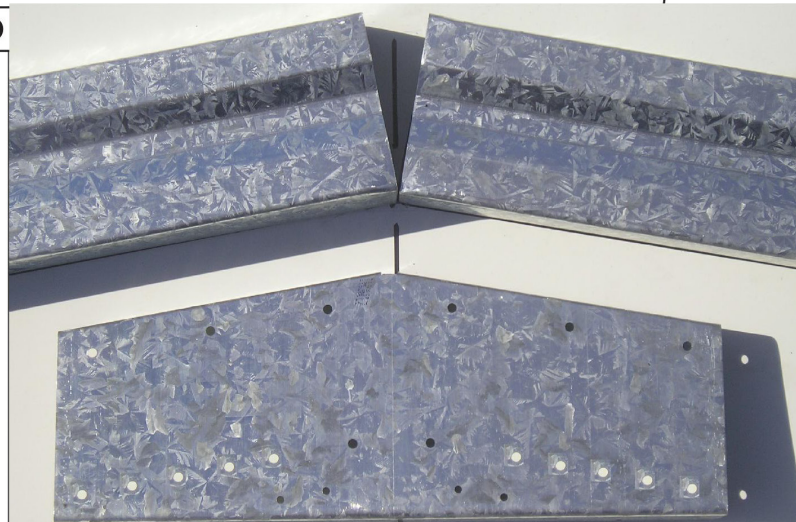

## HIGH CENTRE PORTAL ASSEMBLY SUPPORT PHOTOS

STEP 3.

Join C1482 to C1954

**Step 3a**



**Step 3b**

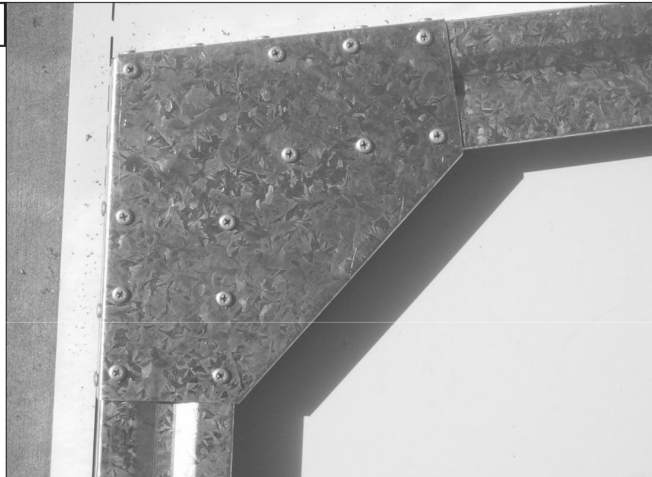

**Step 3c**

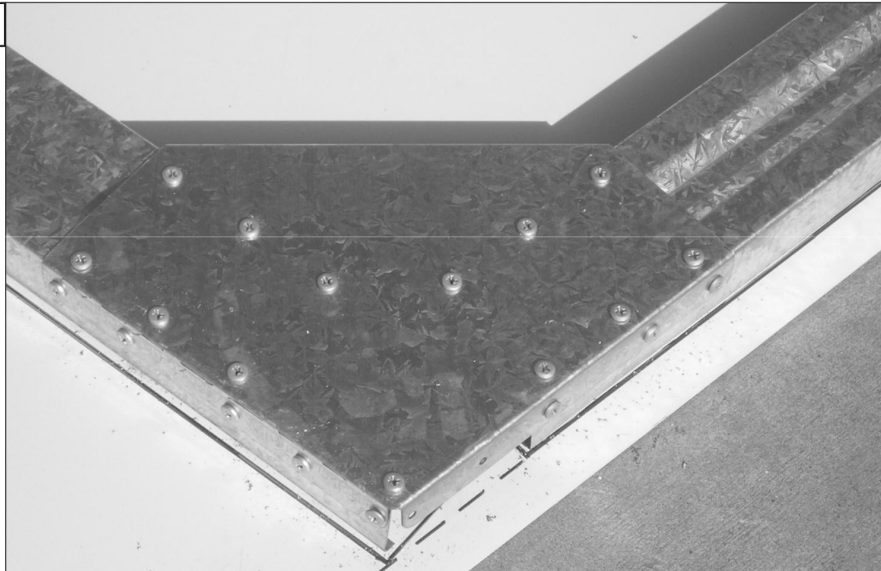

## HIGH CENTRE PORTAL ASSEMBLY SUPPORT PHOTOS

STEP 4.

Join C1482 to C1482

**Step 4a**

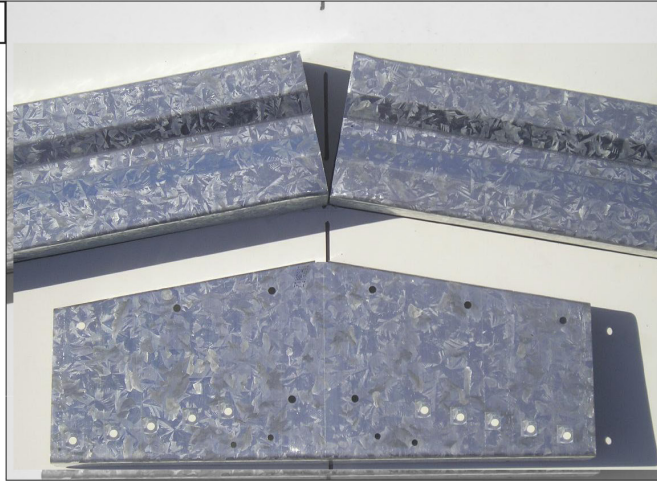

**Step 4b**



**Step 4c**

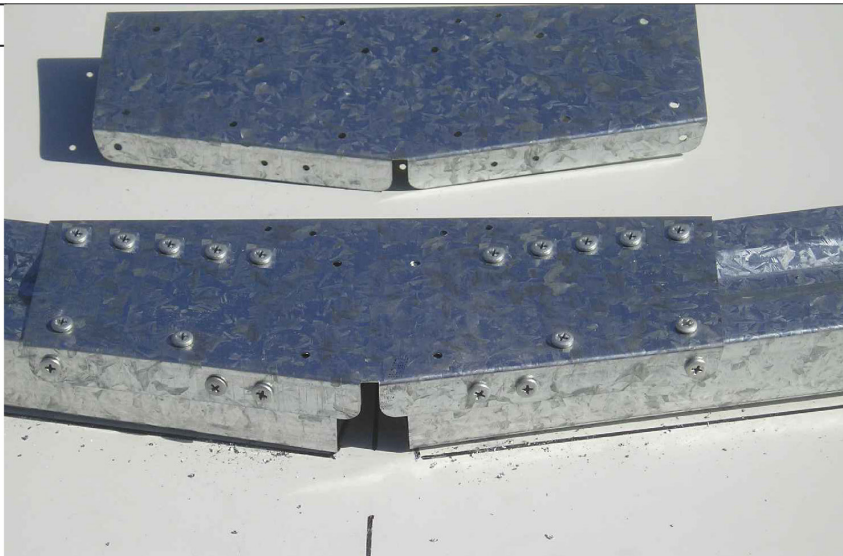

## HIGH CENTRE PORTAL ASSEMBLY SUPPORT PHOTOS

STEP 5.

Secure ridge plate (RBP)

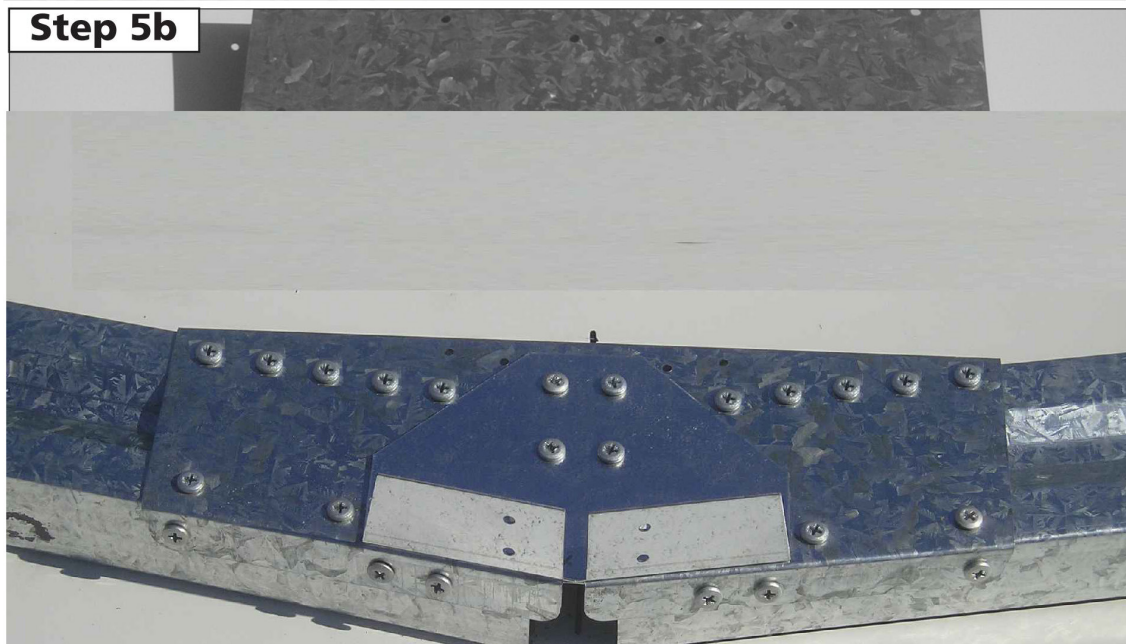



## HIGH CENTRE PORTAL ASSEMBLY SUPPORT PHOTOS

### STEP 6.

Secure multi purpose brackets

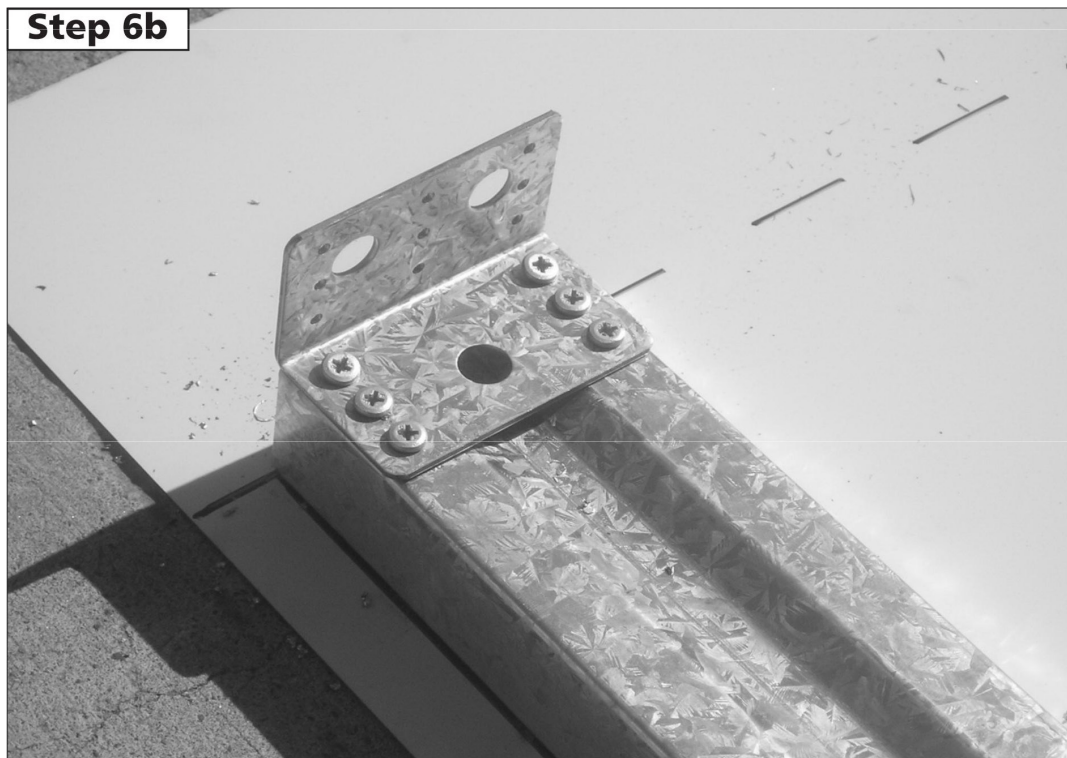
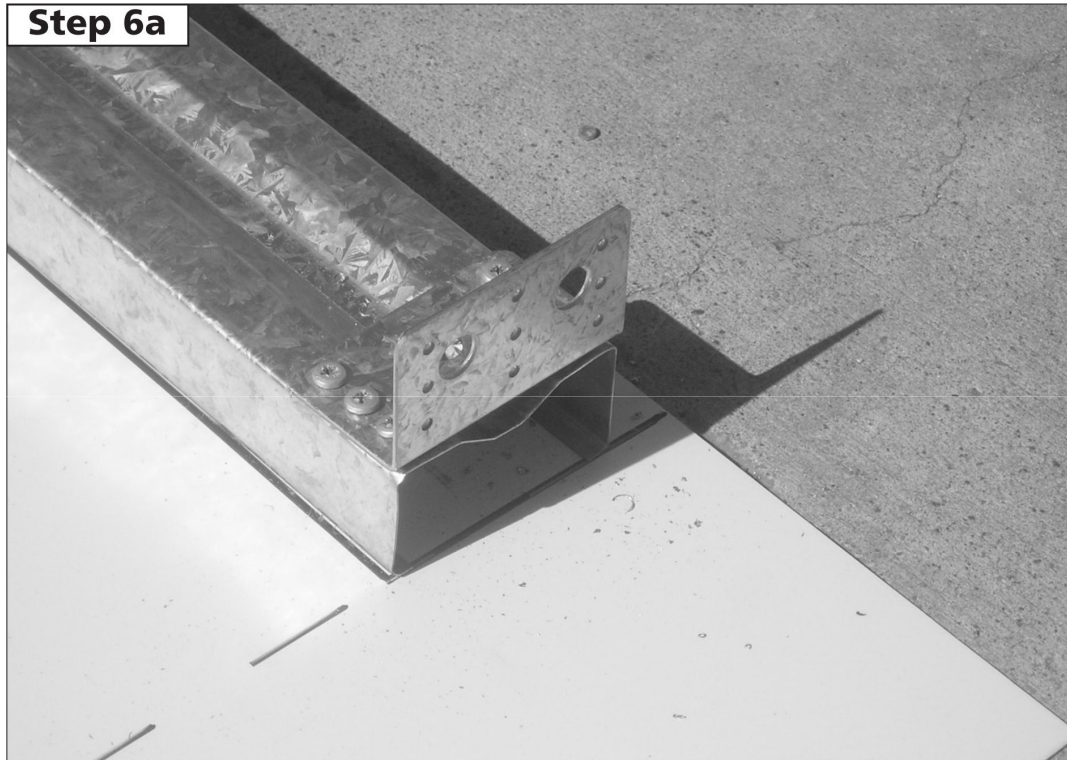

**HIGH CENTRE PORTAL ASSEMBLY SUPPORT PHOTOS**

**STEP 7.**

Turn frame over and repeat steps 4 and 5.

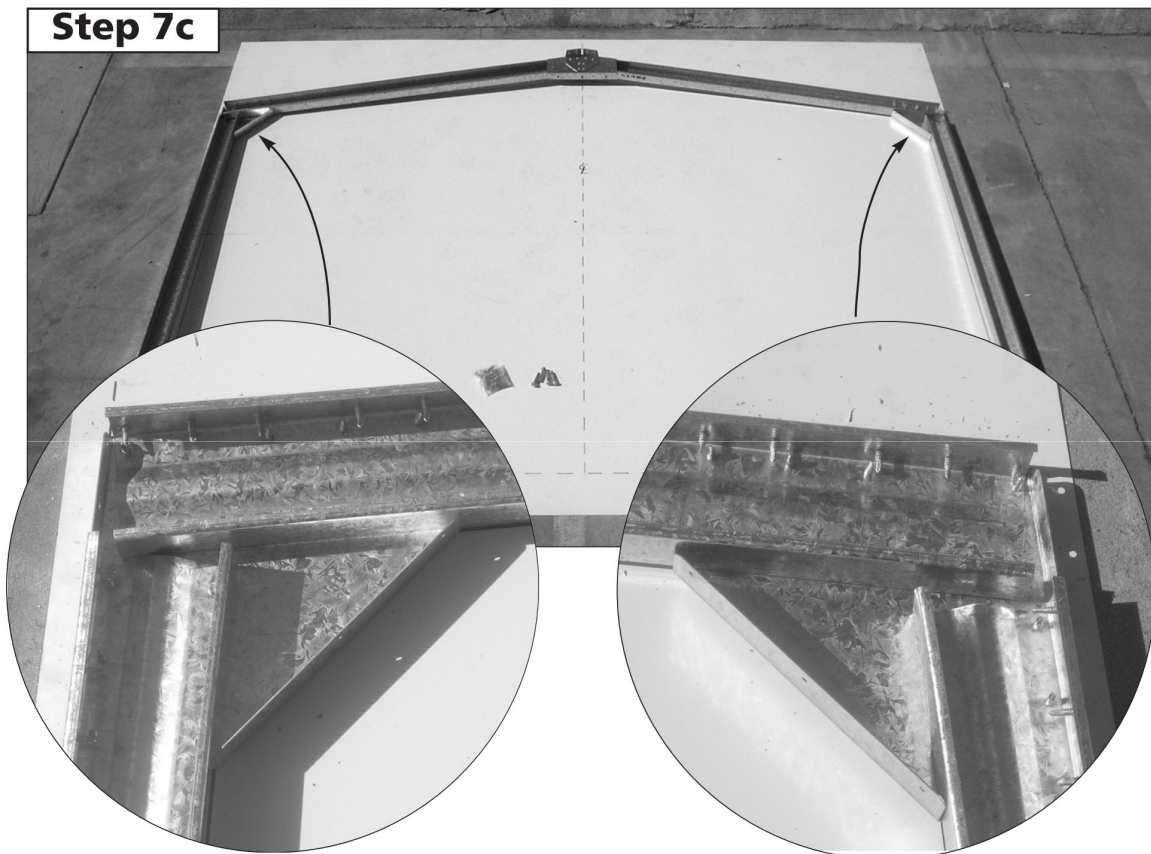
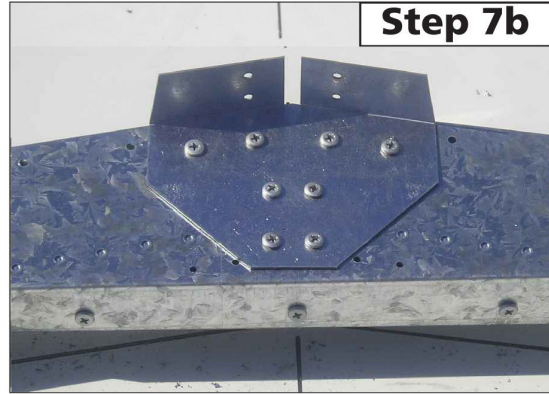
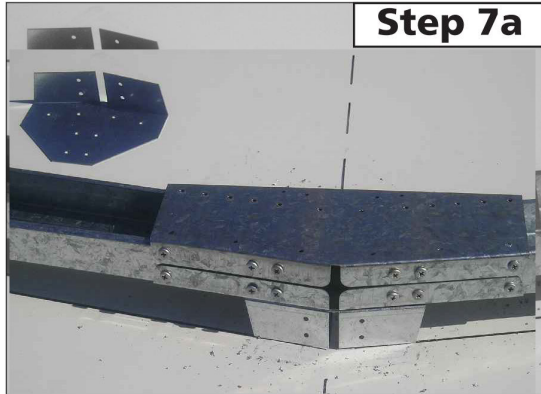

## HIGH FRONT FRAME ASSEMBLY

STEP 1 of 2

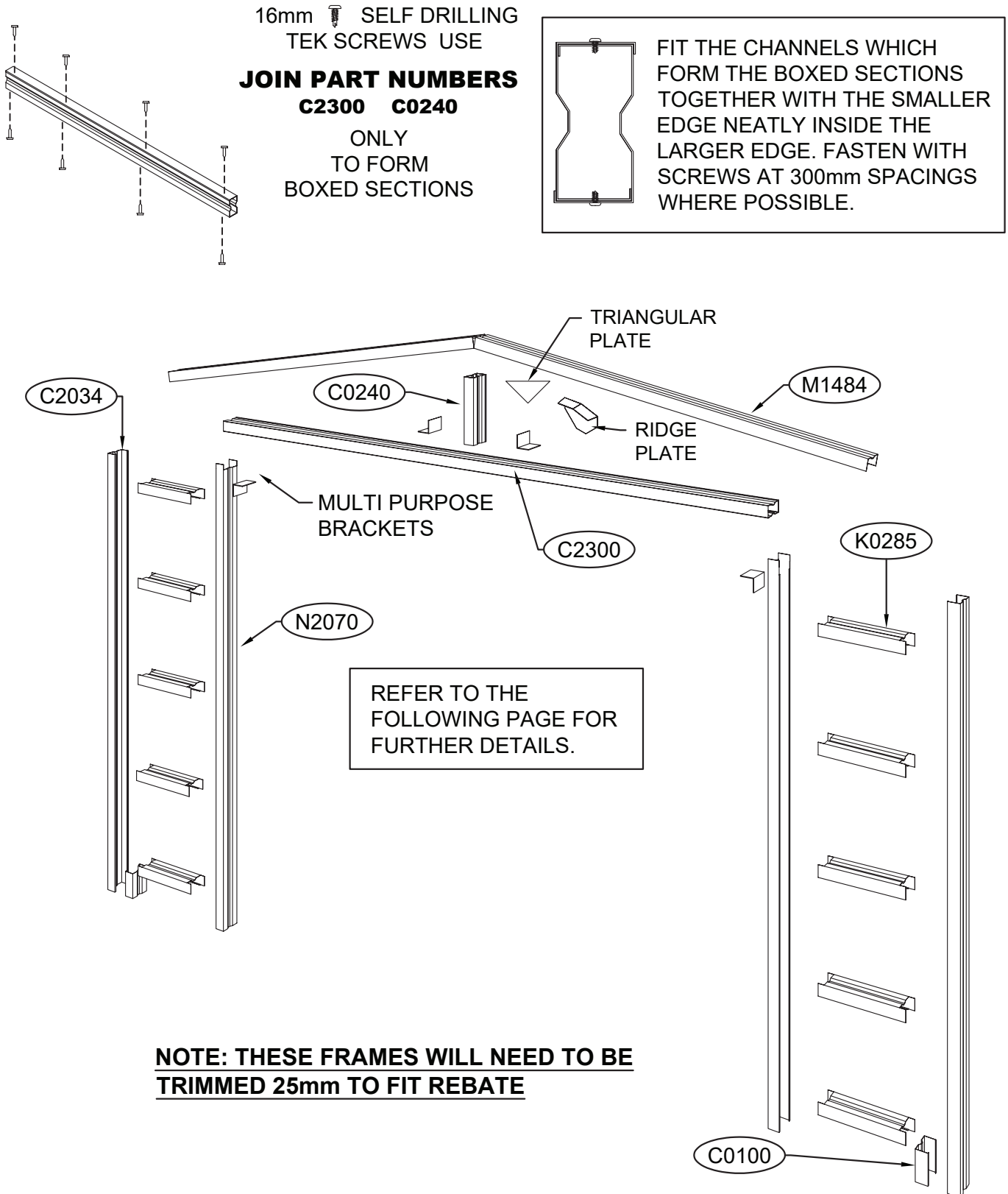

## HIGH FRONT FRAME ASSEMBLY

STEP 2 of 2.

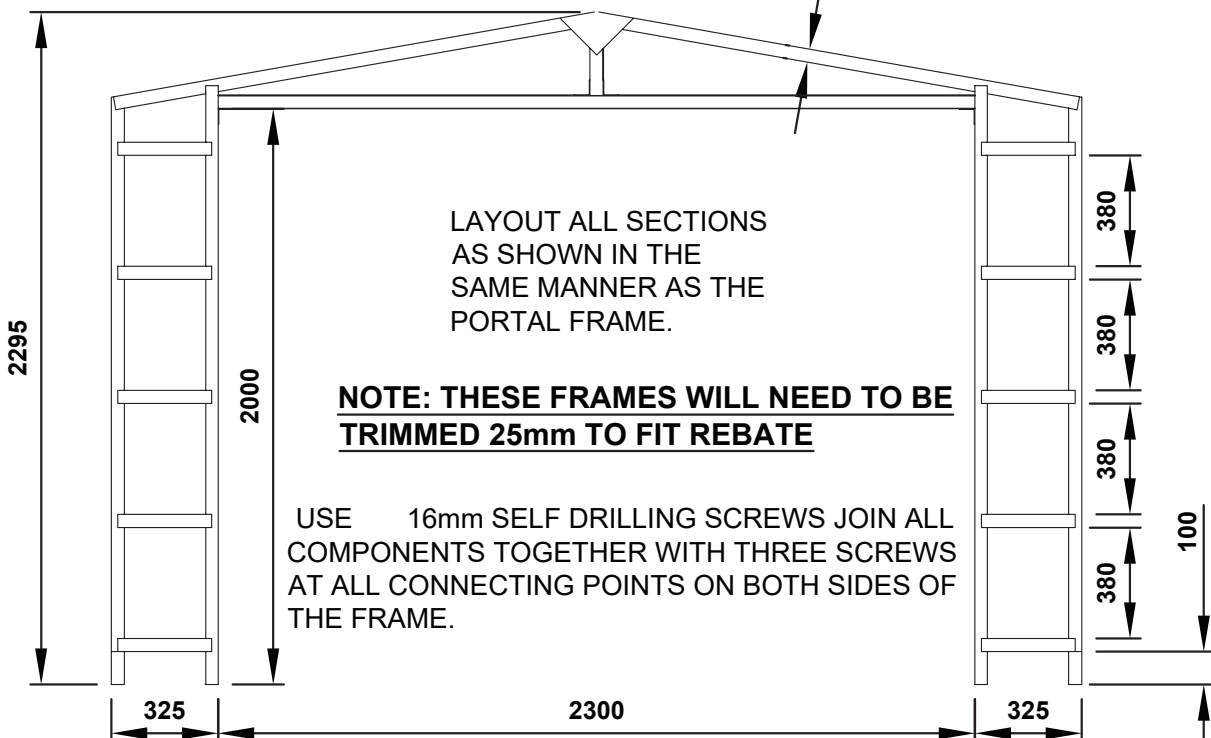
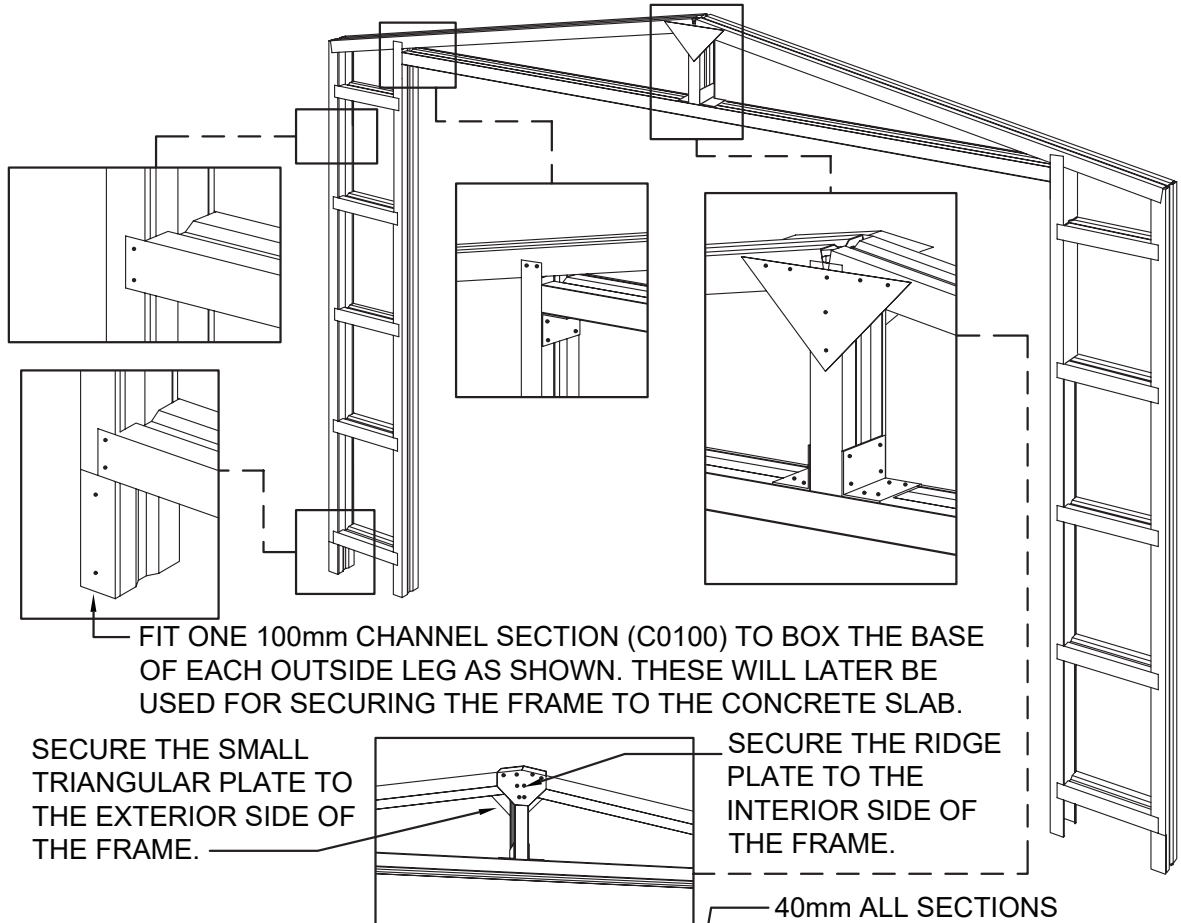

NOTE: IF YOU HAVE AN EDGE REBATE IN YOUR CONCRETE SLAB, YOU WILL HAVE TO CUT AN AMOUNT OFF THE BOTTOM OF THE FRAME LEGS EQUAL TO THE DEPTH OF THE REBATE.

## HIGH FRONT FRAME ASSEMBLY SUPPORT PHOTOS

### STEP 1.

Draw pattern on the concrete in accordance with the dimensions detailed in the assembly instructions.

#### Step 1a

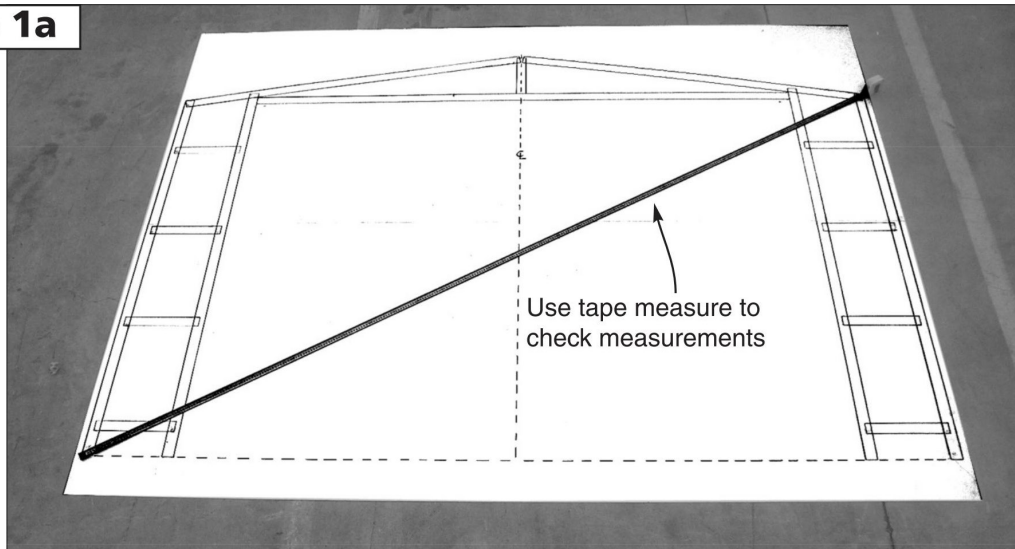

#### Step 1b

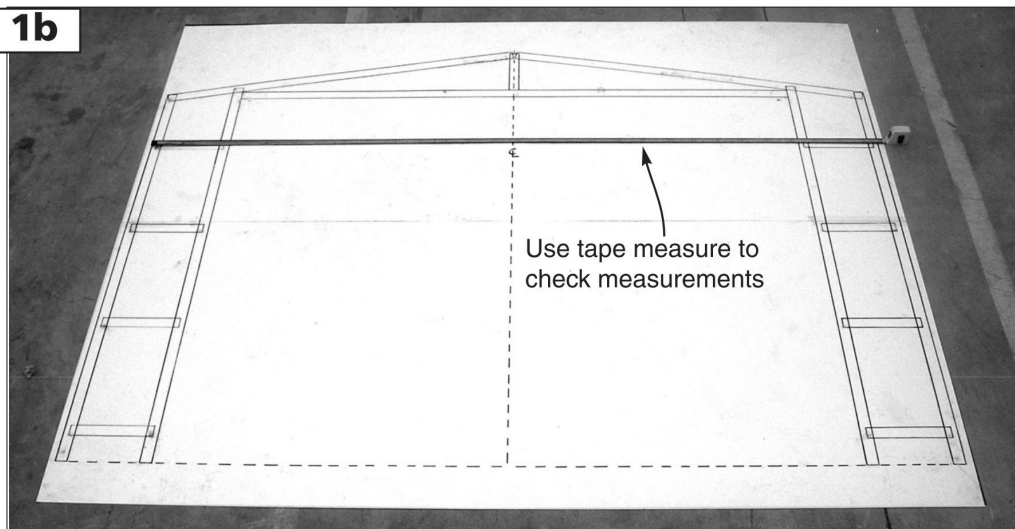

#### Step 1c

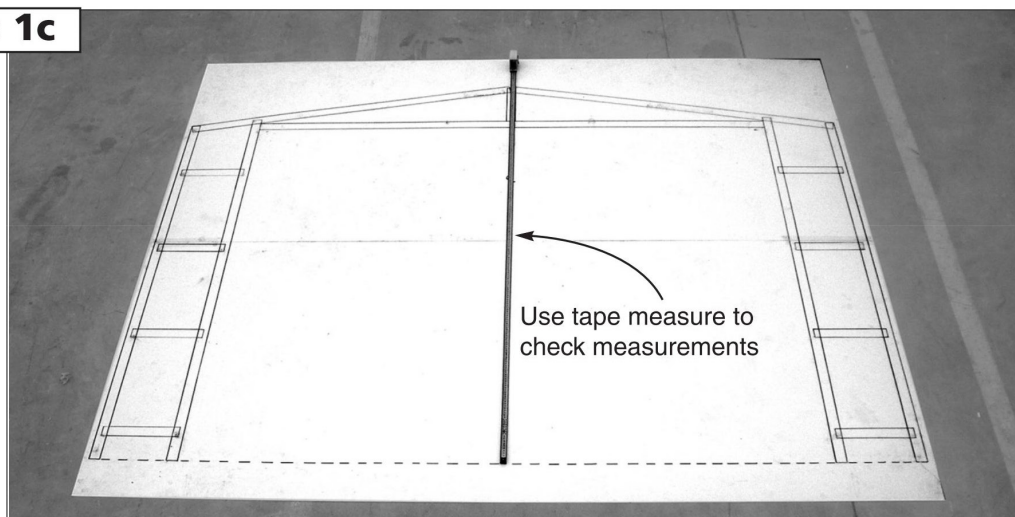

## HIGH FRONT FRAME ASSEMBLY SUPPORT PHOTOS

### STEP 2.

Understand where components are to be positioned.

#### Step 2

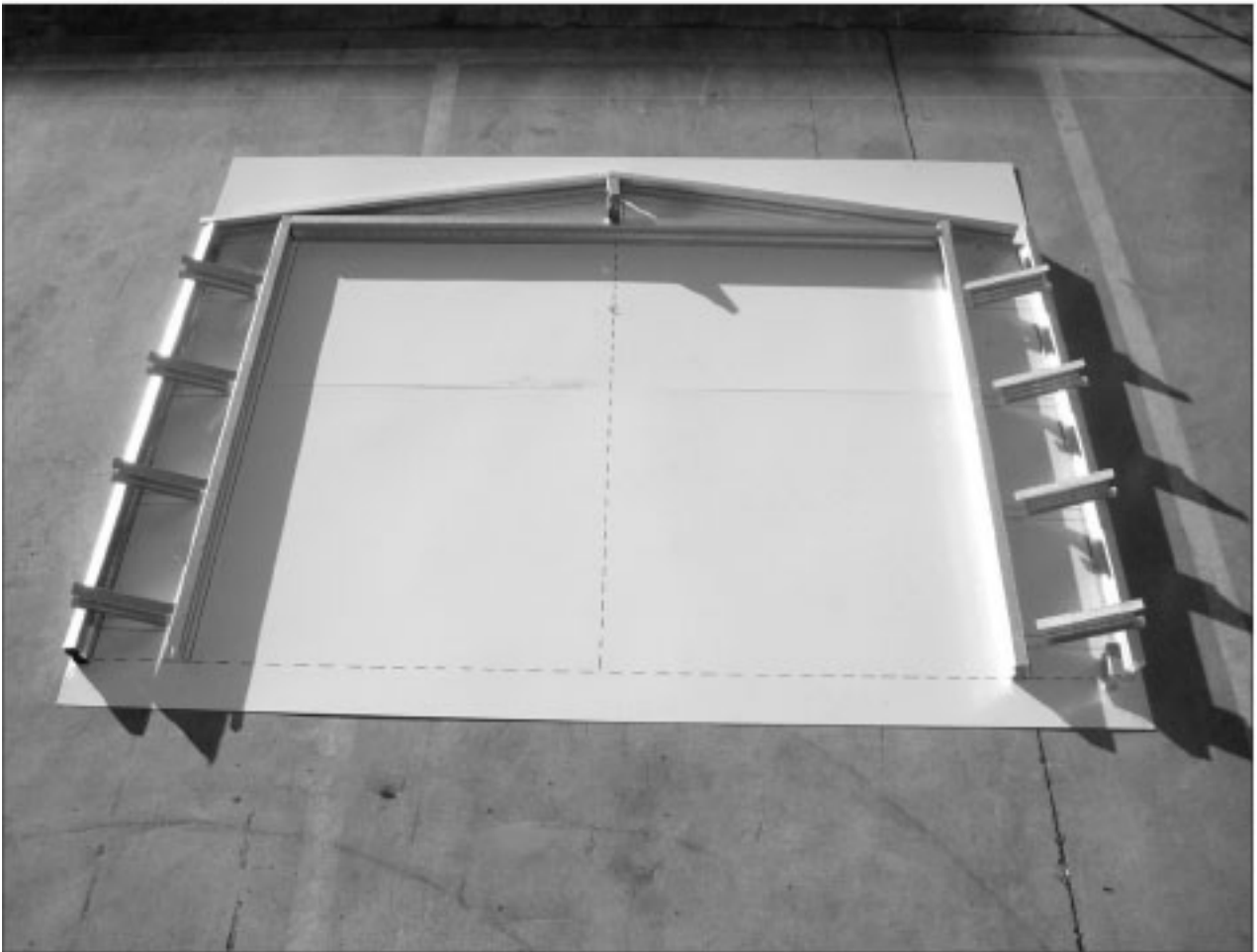

## HIGH FRONT FRAME ASSEMBLY SUPPORT PHOTOS

### STEP 3.

Join C0100 to C2034

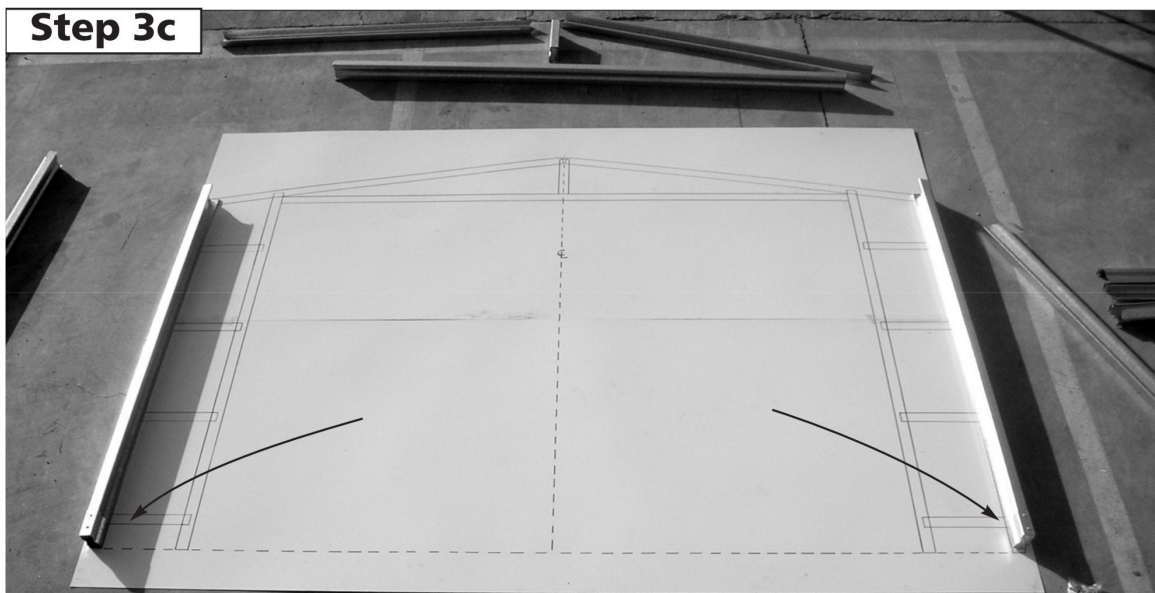
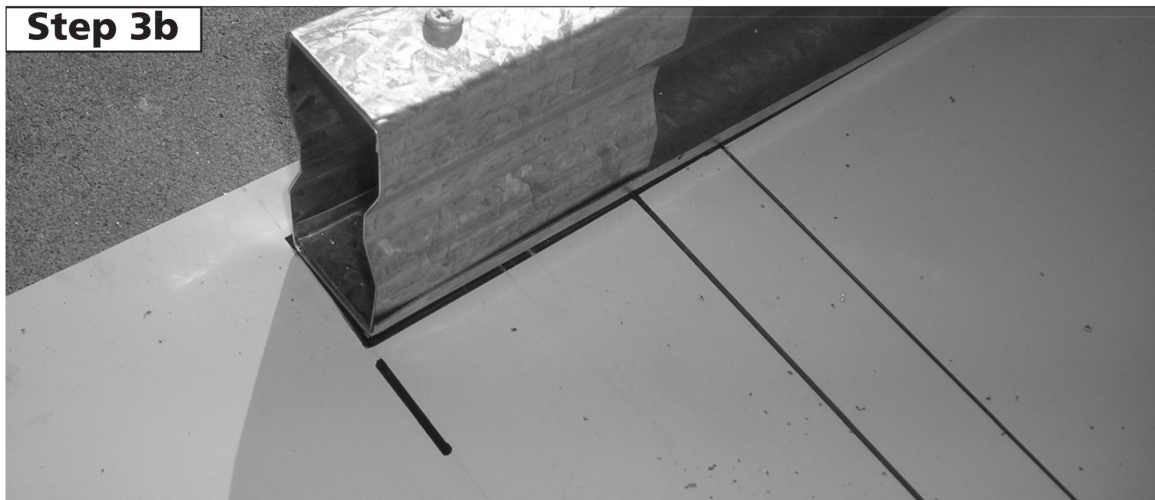
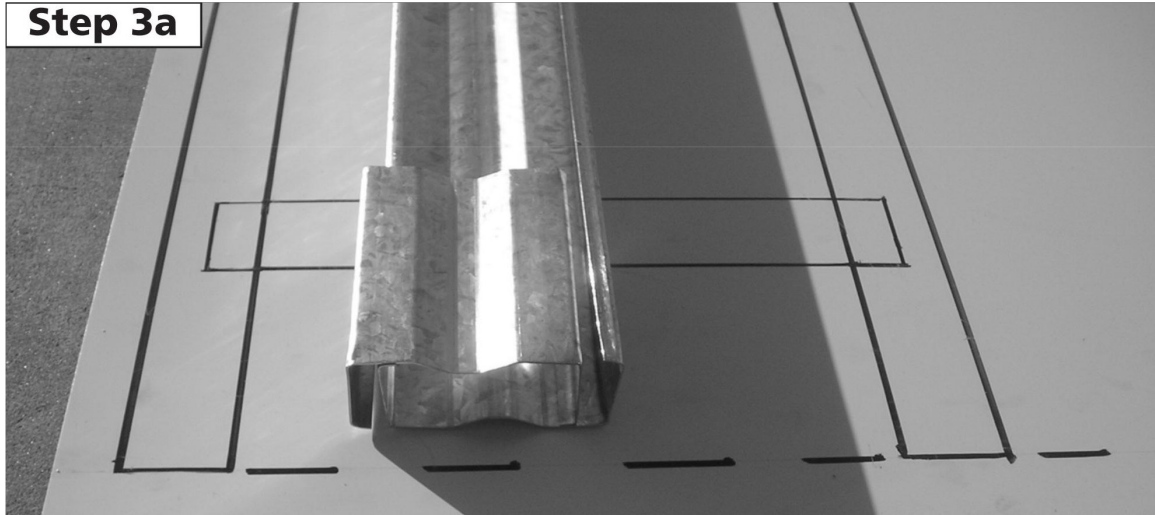

## HIGH FRONT FRAME ASSEMBLY SUPPORT PHOTOS

STEP 4.  
Join C2034 to M1484

**Step 4a**



**Step 4b**

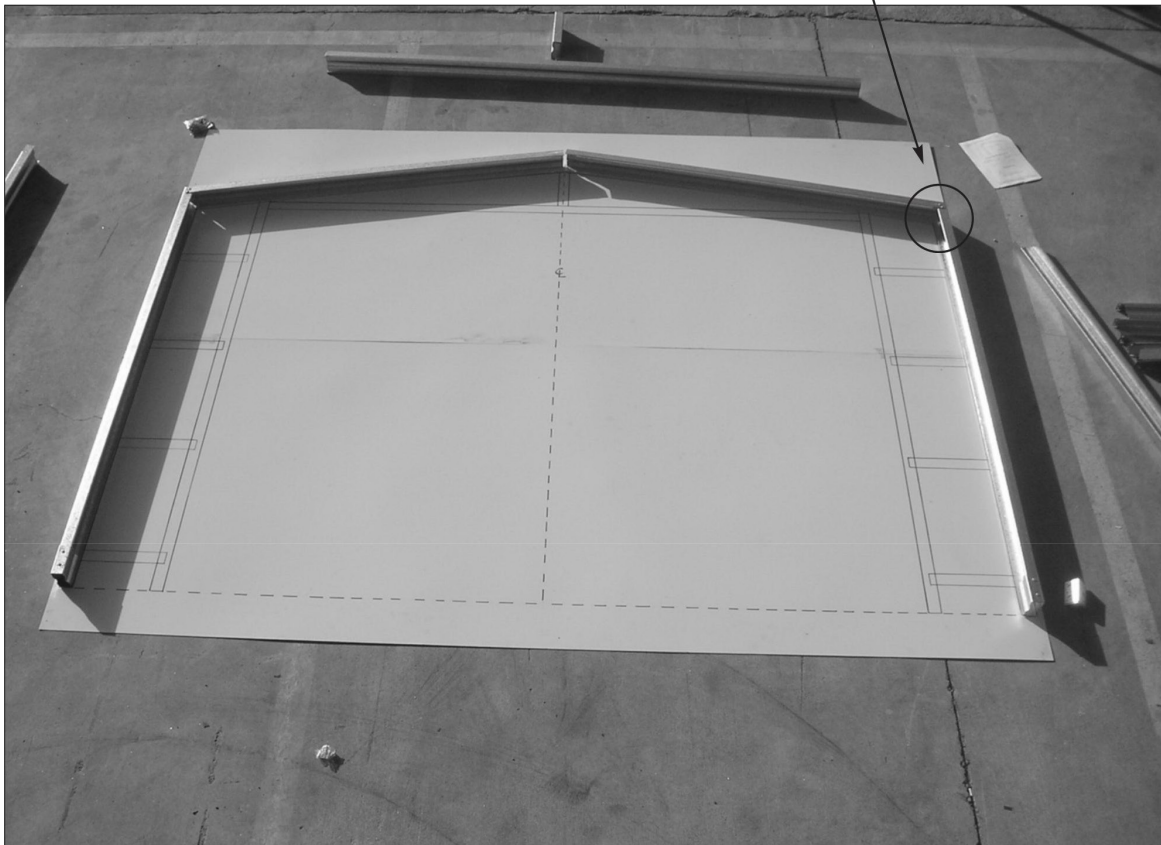



**HIGH FRONT FRAME ASSEMBLY SUPPORT PHOTOS**

STEP 5.

Join K0285 to C2034 & N2070.

**Step 5a**



**Step 5b**

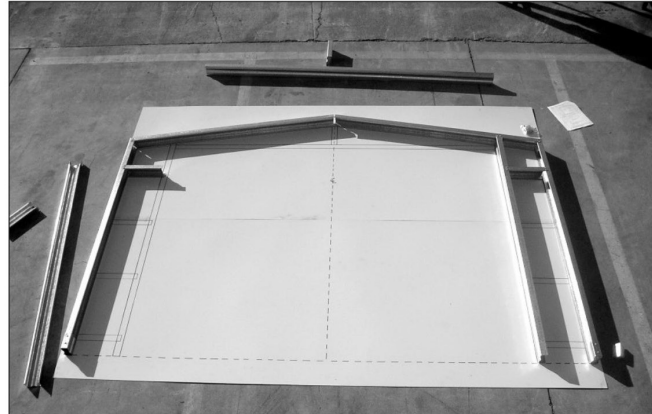

**Step 5c**



**Step 5d**

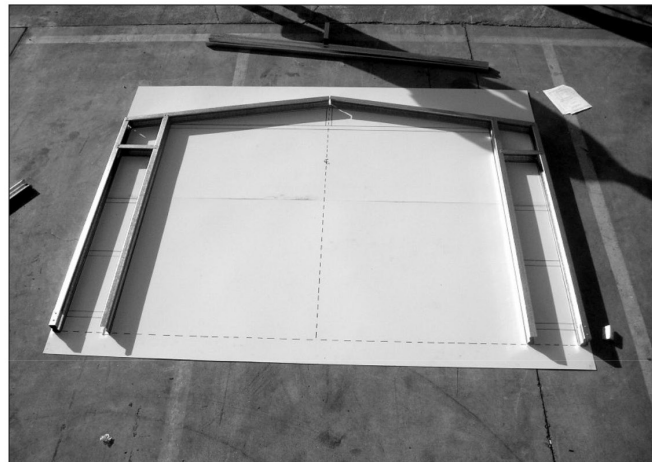

**Step 5e**

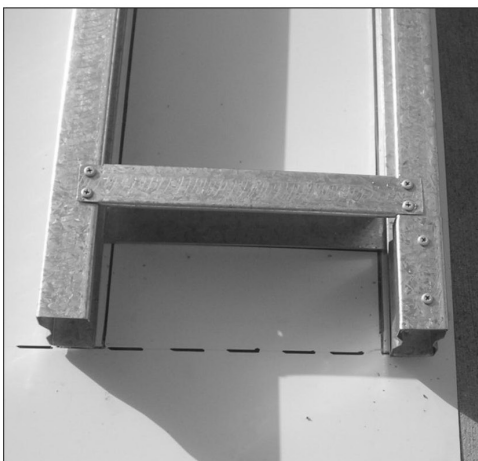

**Step 5f**

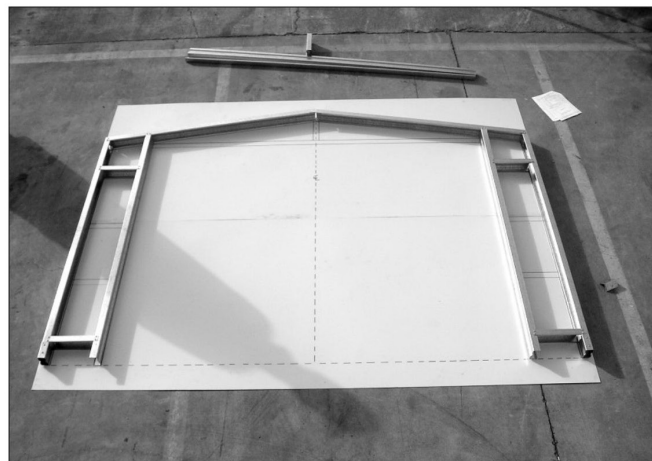

## HIGH FRONT FRAME ASSEMBLY SUPPORT PHOTOS

STEP 6.

Fit multipurpose brackets.

**Step 6a**

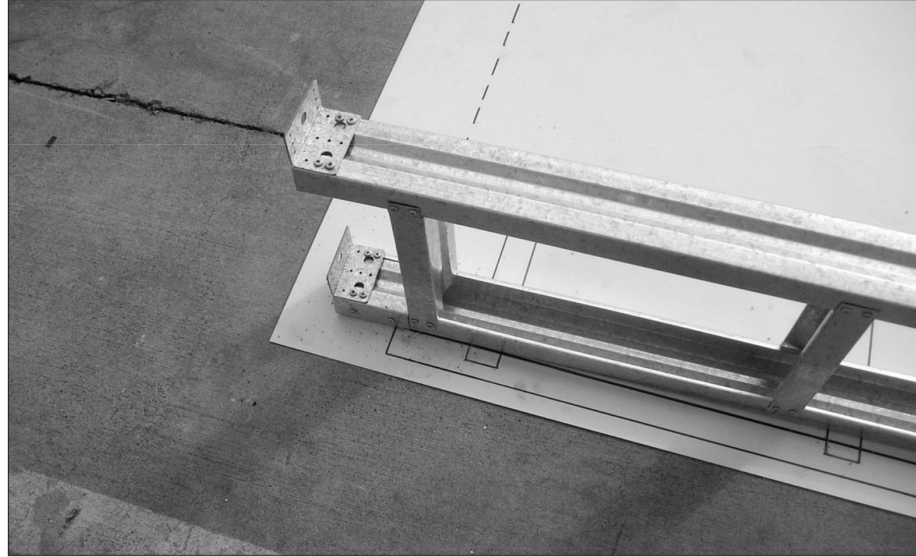

**Step 6b**

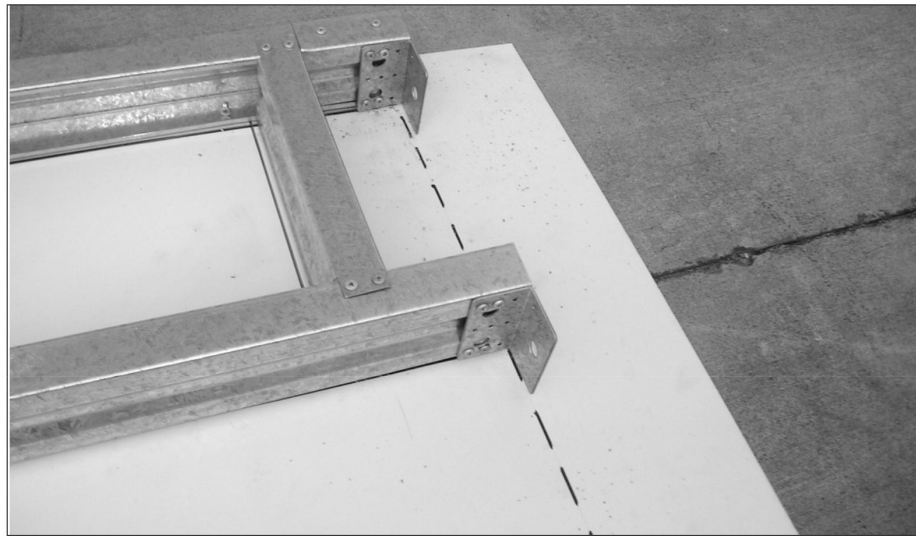

**Step 6c**

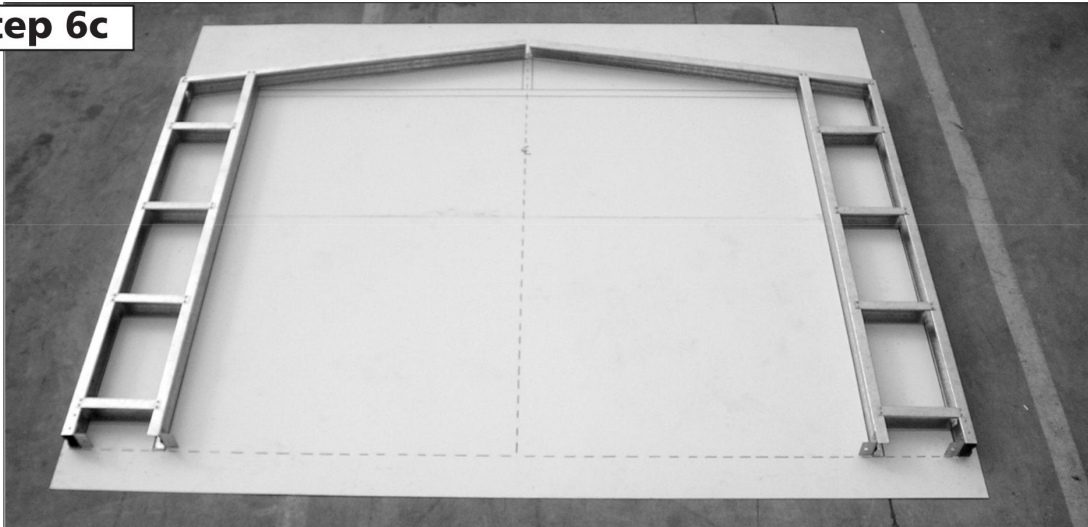

**HIGH FRONT FRAME ASSEMBLY SUPPORT PHOTOS**

STEP 7.

Assemble the C0240 & C2300 sections.

**Step 7a**

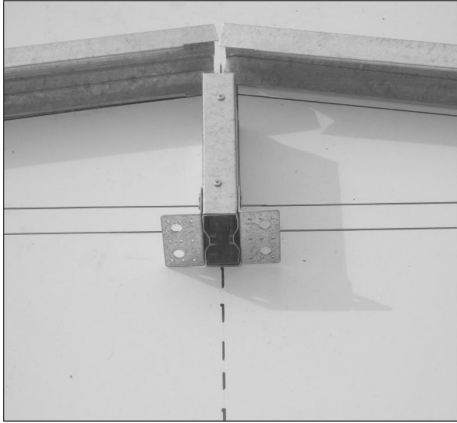

**Step 7b**

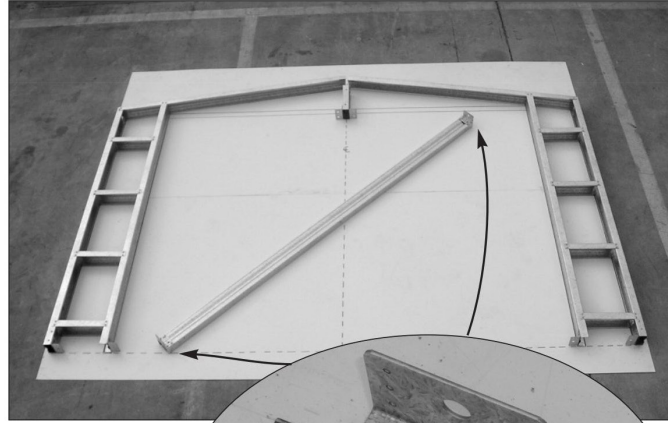

**Step 7c**

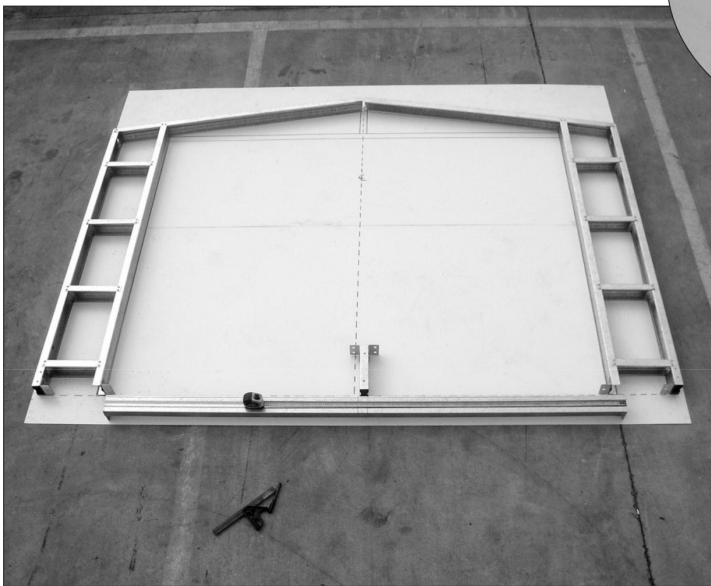

**Step 7d**

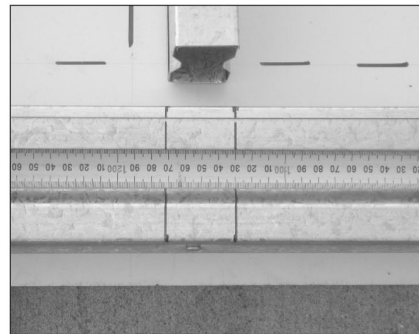

**Step 7e**

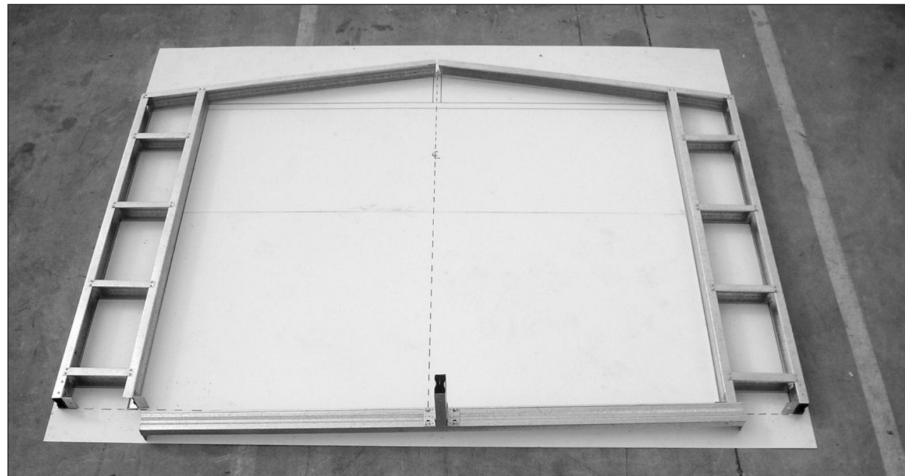

## HIGH FRONT FRAME ASSEMBLY SUPPORT PHOTOS

STEP 8.  
Join all sections together.

**Step 8a**



**Step 8b**

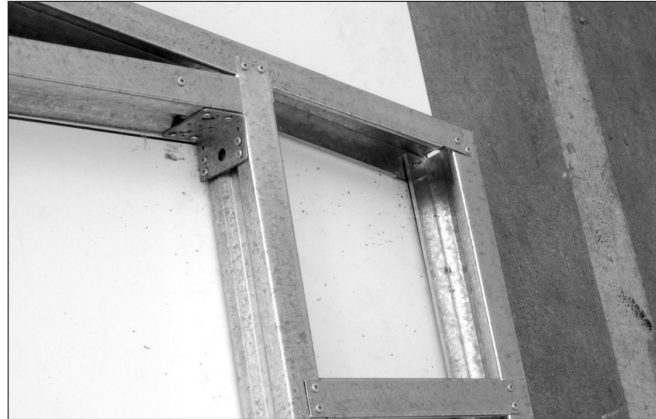

**Step 8c**



**Step 8d**



**Step 8e**



## HIGH FRONT FRAME ASSEMBLY SUPPORT PHOTOS

### STEP 9.

Turn over frame and repeat steps 4 to 8.

#### Step 9a

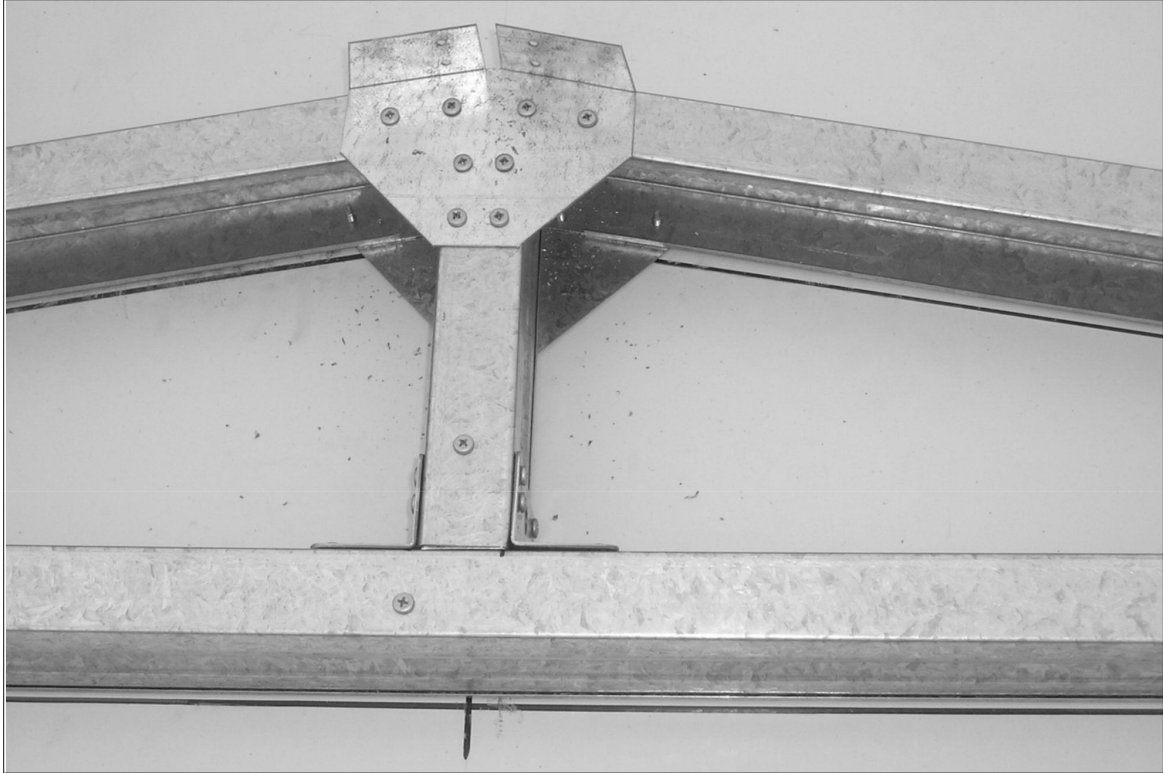

#### Step 9b



## HIGH FRONT FRAME ASSEMBLY SUPPORT PHOTOS

STEP 10.

Fully assembled front frame.

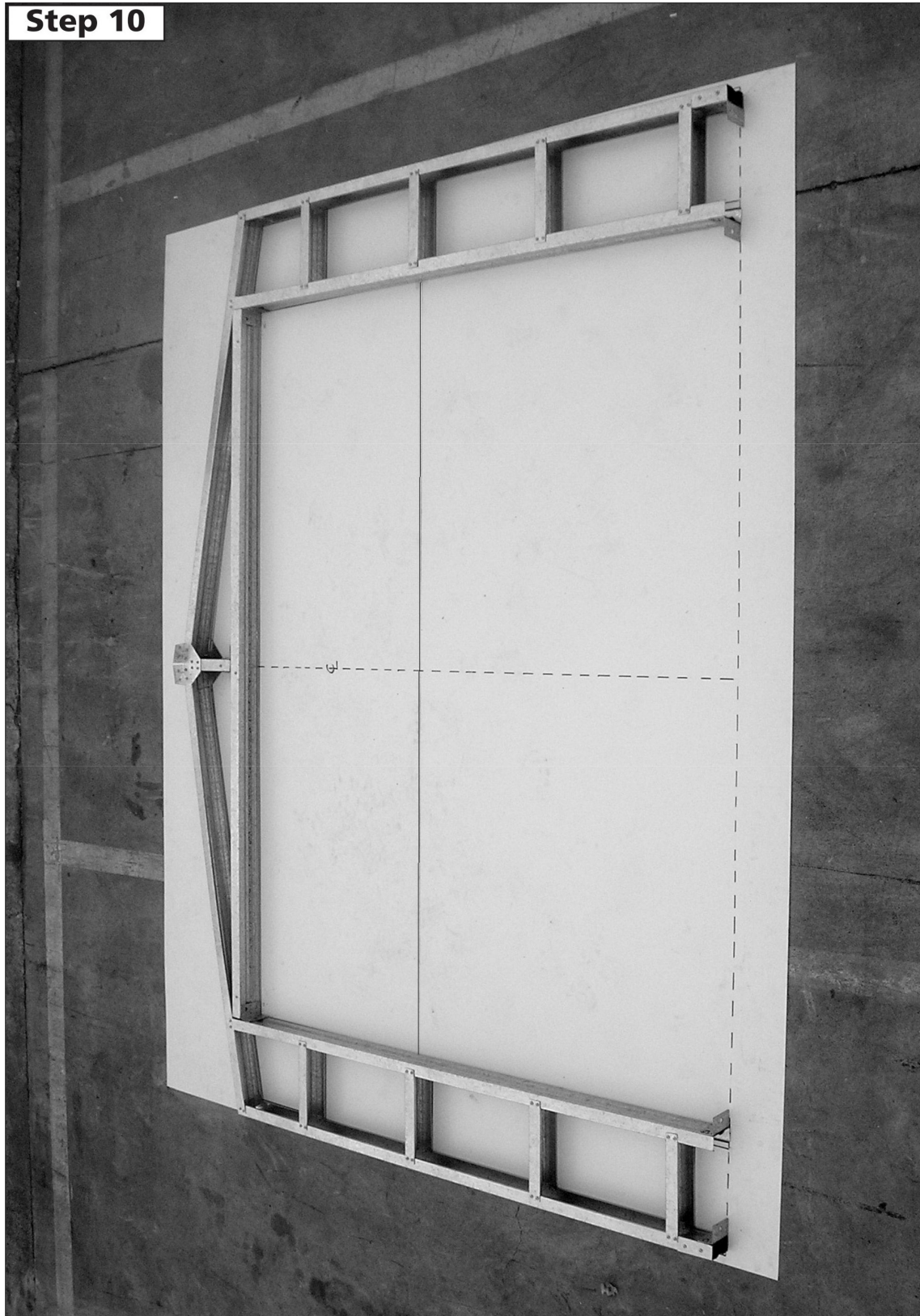

## FRONT PANEL ASSEMBLY

1 required.

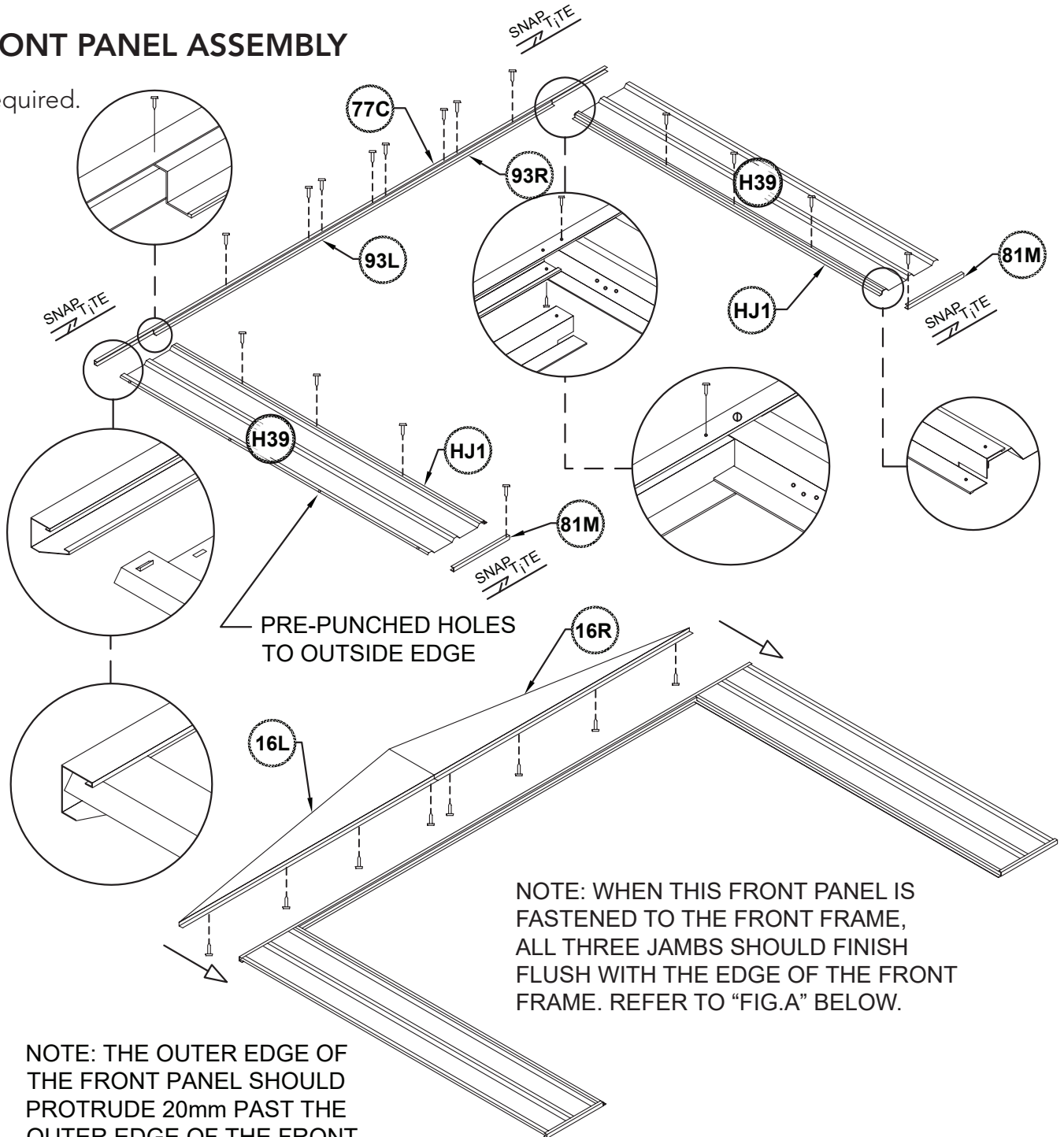

NOTE: WHEN THIS FRONT PANEL IS FASTENED TO THE FRONT FRAME, ALL THREE JAMBS SHOULD FINISH FLUSH WITH THE EDGE OF THE FRONT FRAME. REFER TO "FIG.A" BELOW.

NOTE: THE OUTER EDGE OF THE FRONT PANEL SHOULD PROTRUDE 20mm PAST THE OUTER EDGE OF THE FRONT FRAME FOR CORNER LAPPING OF SIDE WALL PANELS. (FIG. B)

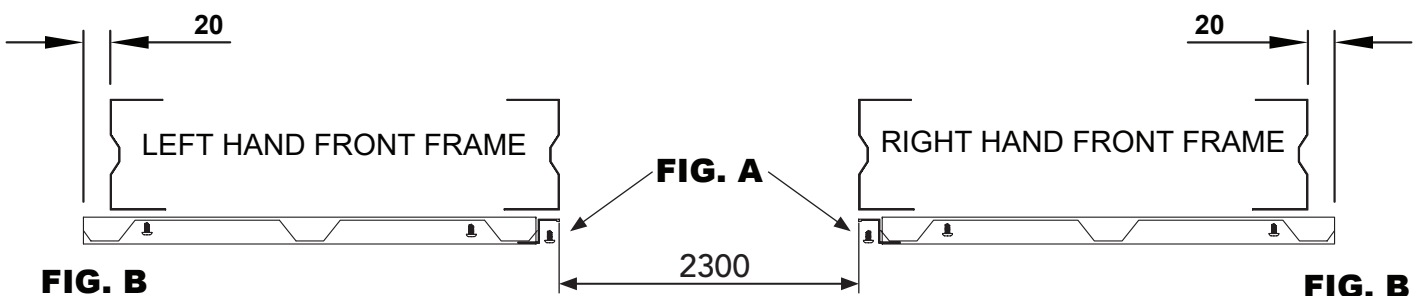

## HIGH PORTAL FRAME DETAILS

Recommended slab dimensions - 6060mm x 3100mm  
 External wall dimensions - 5960mm x 3000mm  
 Internal wall dimensions - 5920mm x 2960mm

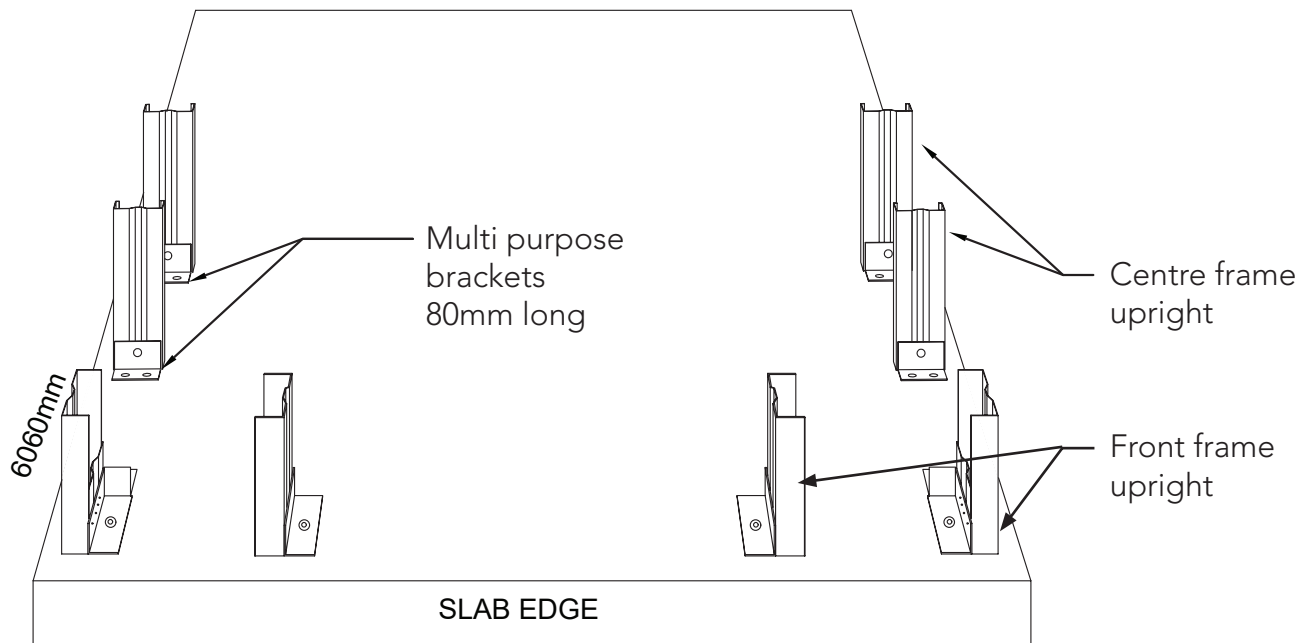
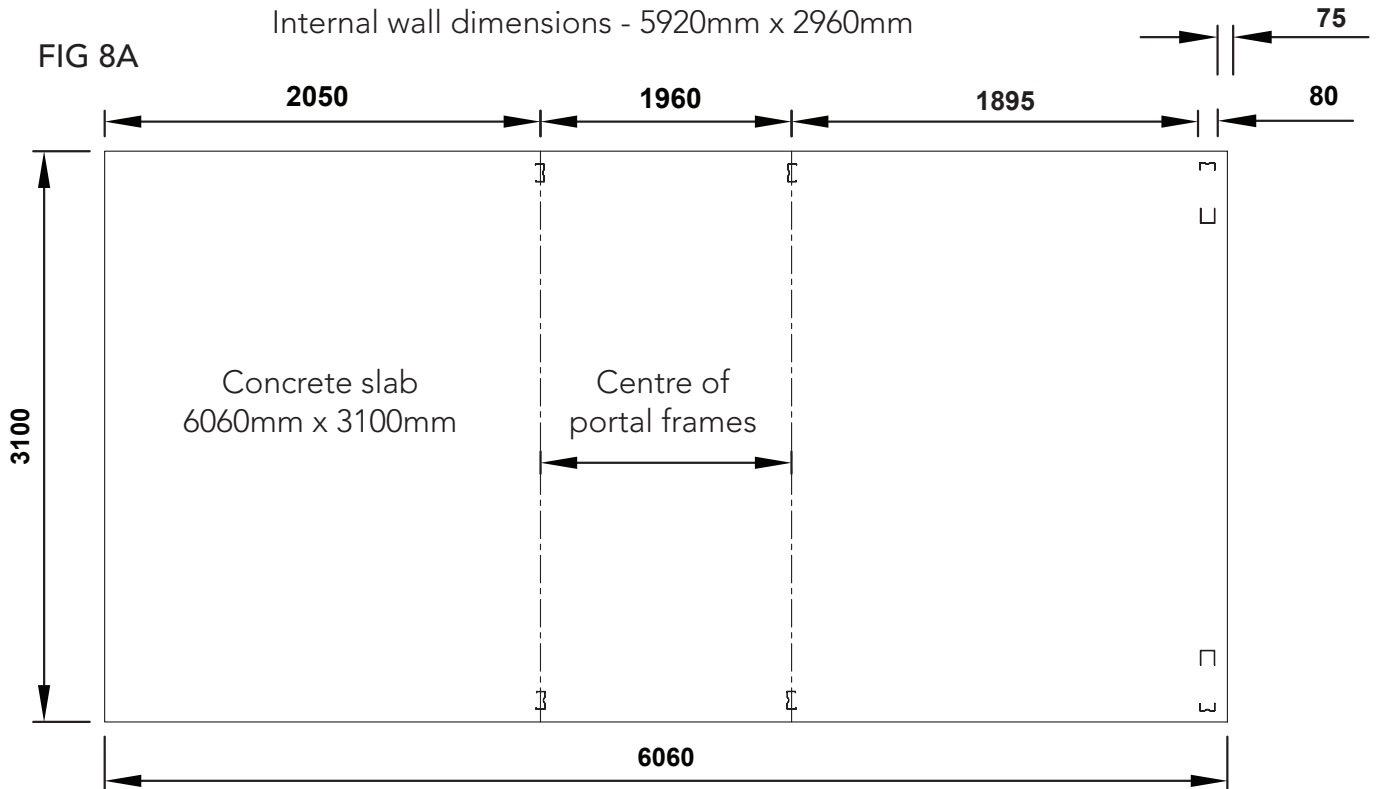

- Secure multipurpose brackets to uprights using self drilling screws
- Move frames into position, mark and drill holes in slab using 10mm masonry drill bit
- Secure frames to slab with M10 dynabolts.



## PANEL CONSTRUCTION

NOTE: Take care to ensure that all wall panels are not upside down. The top channels of each panel are pre-punched for attaching roof sheeting. The base channels are not.

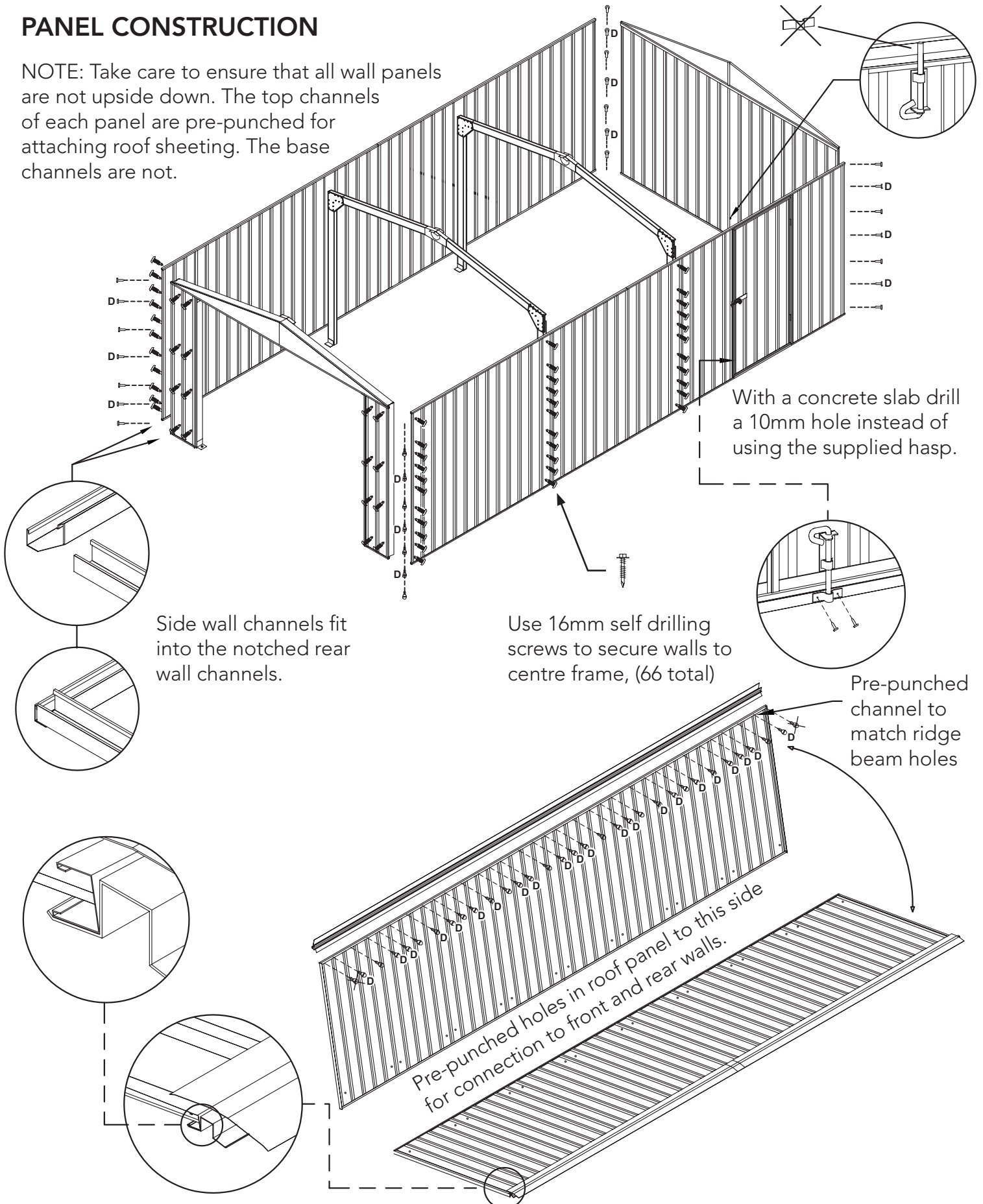

### ROOF CONSTRUCTION

#### STEP 1.

Slide the roof panels into position and secure with only one screw in each corner at this stage.

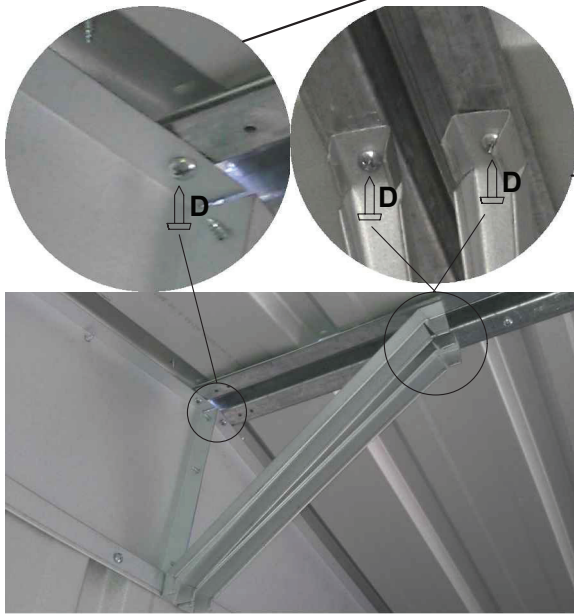

INSIDE VIEW

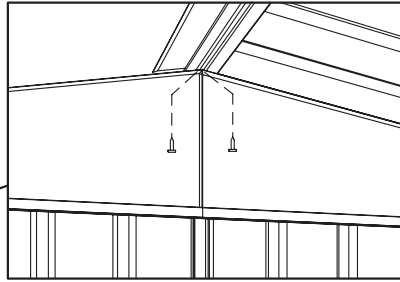

#### STEP 2.

Secure ridge beam to gable sections with two screws at either end.

INSIDE VIEW

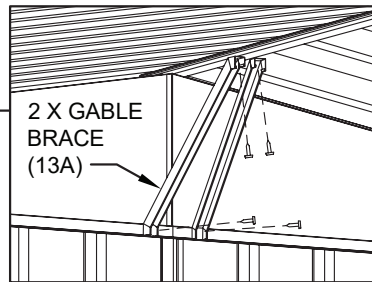

#### STEP 3.

After the roof panels have been secured, fit two gable braces (13A) from the top wall channel to the underside of the ridge beam at 45 degrees as shown to both gable walls

NOTE: This symbol  denotes that holes to be pre-drilled with a 3mm drill bit before fastening.

**- WARNING -**

**Do not climb on or walk on the roof.**

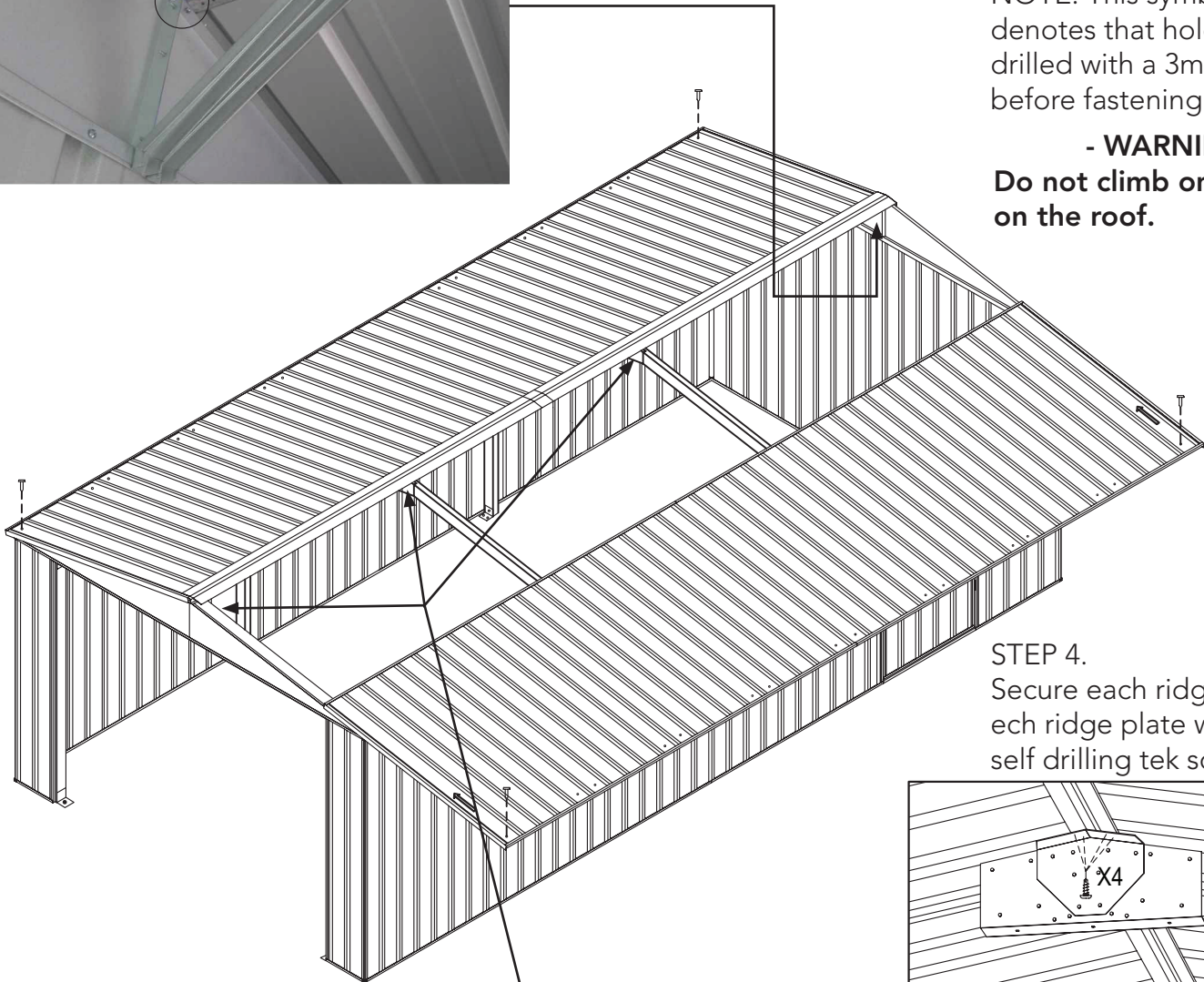

#### STEP 4.

Secure each ridge beam to each ridge plate with 4x 16mm self drilling tek screws.

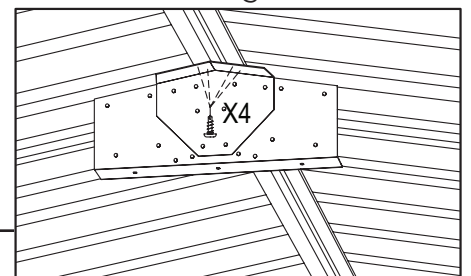

### FINAL CONSTRUCTION

**STEP 1.**  
Secure the roof panels to the wall panels as shown.

**STEP 2.**  
Secure the roof panels to the internal frames with self drilling tek screws.

**STEP 3.**  
Secure the portal frames to the ridge beam as detailed on the previous page.

**STEP 4.**  
Bend the top and bottom flanges as shown, then hook the bottom flanges under the top channel and screw top to the ridge beam with two screws.

### ANCHORING OF SHED

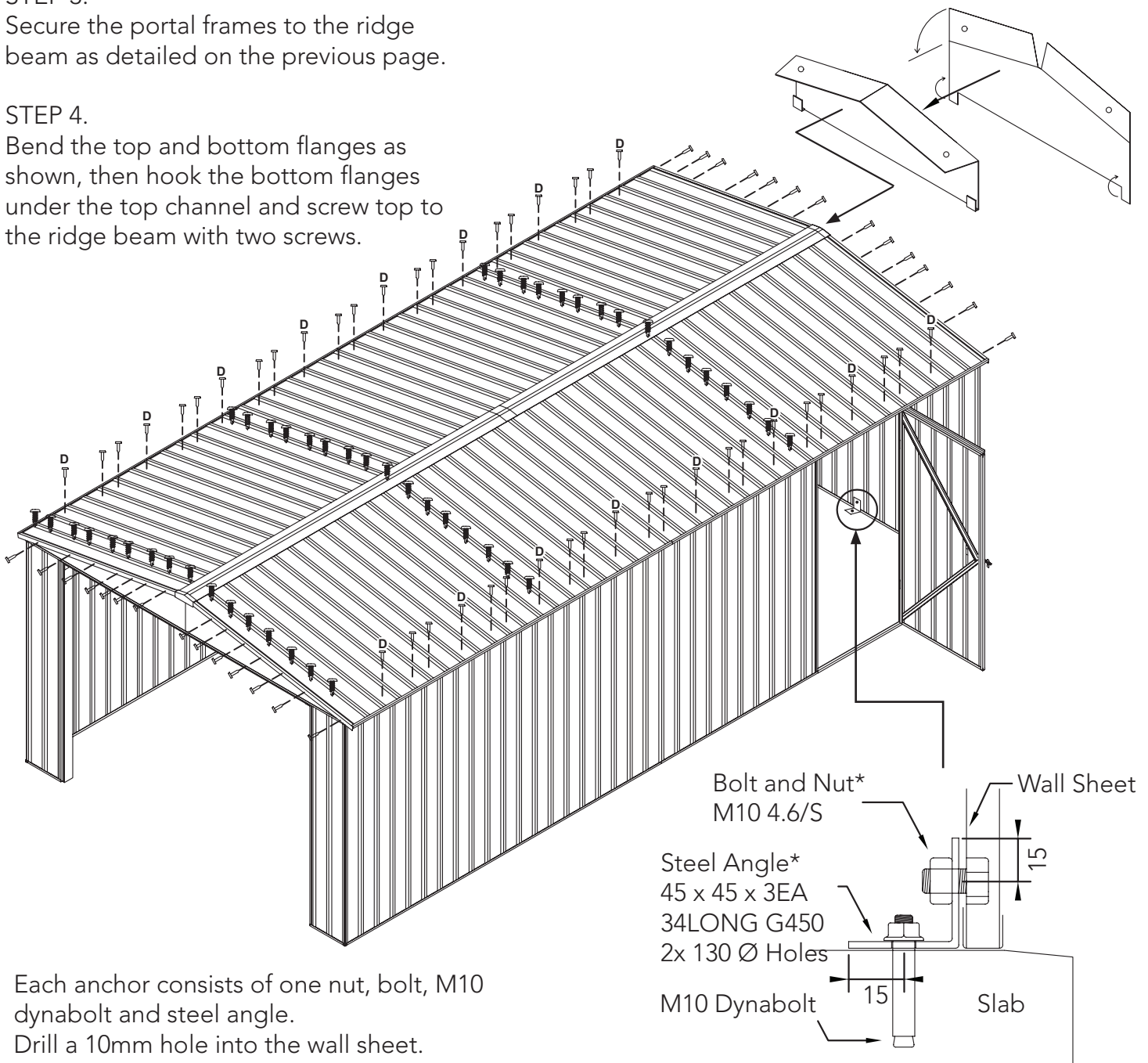
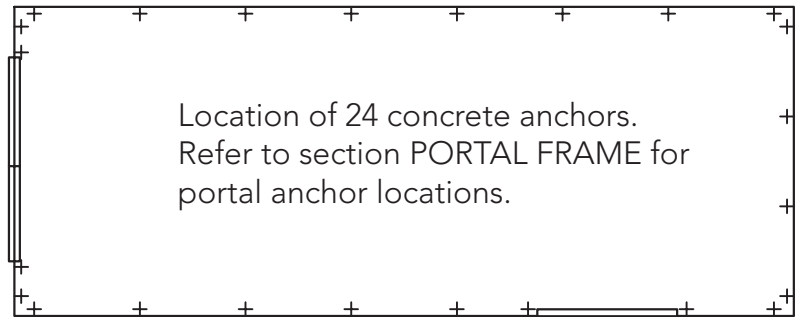

Each anchor consists of one nut, bolt, M10 dynabolt and steel angle.  
Drill a 10mm hole into the wall sheet.  
Drill a 10mm hole into the concrete.

\* Denotes hot dip galvanised finish

### DOOR INSTALLATION

Secure front doors to the front panel in the same manner as the side door was fitted.

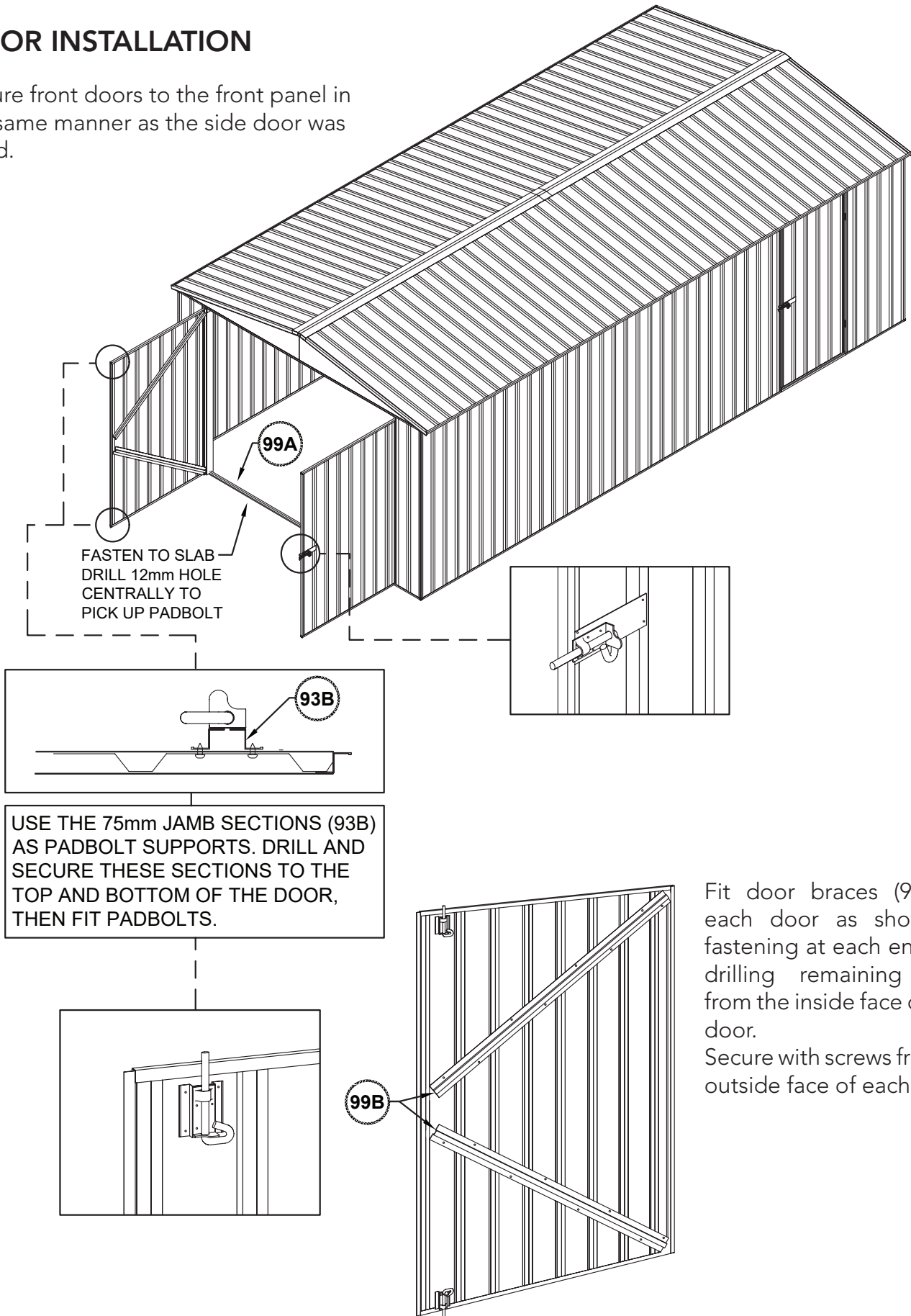

FASTEN TO SLAB  
DRILL 12mm HOLE  
CENTRALLY TO  
PICK UP PADBOLT

USE THE 75mm JAMB SECTIONS (93B) AS PADBOLT SUPPORTS. DRILL AND SECURE THESE SECTIONS TO THE TOP AND BOTTOM OF THE DOOR, THEN FIT PADBOLTS.

Fit door braces (99B) to each door as shown by fastening at each end then drilling remaining holes from the inside face of each door. Secure with screws from the outside face of each door.

## Absco Large Gable Roof Shed Notes

### General

- 1.G This instruction manual shall be read in conjunction with other consultants drawings, specifications and written instructions provided by Absco and/or their representatives.
- 2.G The drawings provided herein are for installation and structural engineering purposes only. If discrepancies are discovered within the documentation provided, these shall be brought to the attention of Absco and written approvals obtained prior to commencing the affected section of work.
- 3.G If in doubt ask.
- 4.G Until approvals from the local authorities are obtained, commencement of construction from these drawings shall not commence.
- 5.G Unless varied by the project specification, all materials and workmanship shall be undertaken in accordance with the relevant Australian standards and the by-laws and ordinances of the relevant building authorities.
- 6.G All dimensions indicated in these drawings shall be verified on site by the installation contractor. Scaling of drawings shall not be undertaken.
- 7.G Prior to commencing works on site, the contractor shall verify the position of all services in the area to ensure that the construction does not interfere with any of those services.
- 8.G During installation on site the shed structures shall be maintained in a stable condition with no part becoming overstressed or permanently deformed.
- 9.G In circumstances where the shed has been installed in a manner which is inconsistent with the installation manual, structural certification shall be void.
- 10.G The structural components detailed within this installation manual have been designed for the following loads in accordance with AS/NZS1170 based on a Class 10a, Type 2 structure:
- Roof Live Load: 0.25 kPa uniformly distributed or 1.1 kN concentrated as per AS/NZS1170.1

Wind Load: Classification N2, Non-Cyclonic to AS4055 where  $V_u = 40$  m/s,  $V_s = 26$  m/s

Windward wall  $C_{p,e} = 0.7$

Leeward Wall  $C_{p,e} = -0.3$  to  $-0.5$  as applicable based on shed geometry

Side Wall  $C_{p,e} = -0.2$  to  $-0.65$  as applicable based on shed geometry

Roof  $C_{p,e} = -0.3$  to  $-1.04$  depending on wind direction

## Absco Large Gable Roof Shed Notes

### Steelwork

- 1.S All structural steelwork shall have a corrosion protection system applied consistent with AS/NZS 2312-2002.
- 2.S All structural steelwork detailed within this installation manual shall be minimum Grade 550 for roll formed sections (including roof and wall sheeting and portal frame members) and Grade 250 for angle sections.
- 3.S All multi purpose and anchor brackets for connection onto the supporting reinforced concrete slab (includes 45x45x3EA x 34mm long and 47x47x1.9EA x 80 long) shall be minimum Grade 450.
- 4.S All portal frame knee and apex plates shall be minimum Grade 450
- 5.S All roof, and wall sheeting shall be minimum base metal thickness of 0.3mm
- 6.S All portal frame members shall be minimum base metal thickness of 0.75mm.
- 7.S All snaptite channels and jambs shall be minimum base metal thickness of 0.42mm
- 8.S All top hats shall be minimum base metal thickness of 1.0mm
- 9.S All portal frame knee and apex plates shall be minimum base metal thickness 1.0mm
- 10.S All screw fasteners shall be Phil Pan Head Zinc Plated #8 x 3/4" (STP0820)
- 11.S All bolt fasteners for anchoring shall be M10 minimum grade 4.6/S
- 12.S Installation of screw fasteners shall generally be undertaken in accordance with the relevant provisions of AS1562.

## Absco Large Gable Roof Shed Notes

### Supporting Slab and Foundations

- 1.F The supporting slab foundation for the garden shed shall be of a minimum size indicated on the installation manual. The top surface of the formed slab shall be level and free of any irregularities which would inhibit the installation of the shed.
- 2.F The structural engineering design for the supporting slab foundation shall be undertaken by a suitably qualified structural engineer. The design shall consider all relevant provisions of AS3600 and AS2870.
- 3.F Between adjacent footings or excavations, the contractor installing the slab foundation shall not exceed a rise of 1 in a run of 2 in line of slope.
- 4.F Unless approved in writing by the slab foundation engineer, the limits of excavations near existing footings shall be in accordance with that indicated below.

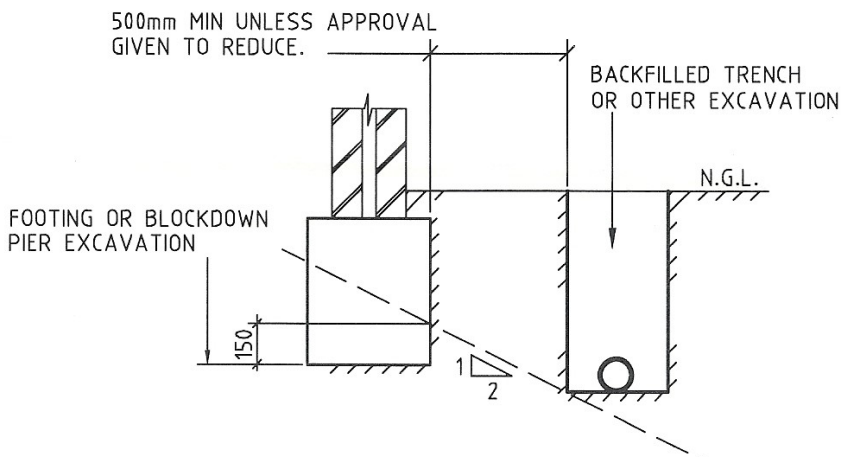

The contractor shall undertake investigatory localised excavations near existing footings to ascertain their depth prior to excavating adjacent to them. It is noted that excavating to a depth below that indicated above shall not be undertaken without the written approval from the engineer.

## Absco Sheds Storage Guidelines

- Absco Sheds are designed to be weatherproof for normal weather conditions. In the event of extreme weather conditions such as heavy rain, combined with high wind gusts, the ridge capping, sheeting joints, screw fixings etc., may exhibit minor deformations which may allow some water entry. These areas should be checked regularly to ensure that maximum strength and protection is maintained.
- Other weather conditions such as extreme heat and extreme cold, moist or dry air can influence the effects of concrete floor moisture and/or condensation on the underside of the roof sheets.
- Absco Sheds and storage units are primarily used for storage of garden equipment such as lawnmowers, wheelbarrows, garden tools etc. Storage items that might be adversely affected by any of the above conditions may require additional protection such as being sealed or covered by plastic sheets and/or stacked above the concrete floor on timber slats.
- Waterproof sealants may be used to offer further protection where required around joins and screw fixings, as can rubber door seals and other products which are available from most hardware outlets.
- Placement of waterproof sealants (silicone) between the base of the shed and concrete slab is not recommended, as this process can have a reverse effect, preventing excess water from escaping, resulting with water accumulating and being trapped inside the shed.
- Absco accepts no responsibility for water entry, floor moisture, condensation or the condition of the Contents inside your Absco steel building arising from any of the pre-mentioned weather conditions.



# Lifetime Warranty Statement



This warranty against defects is given by:

Absco Industries (ABN: 77 869 708 678)  
Address: PO Box 119 Acacia Ridge QLD 4110  
Ph: 1800 029 701  
Fax: 07 3344 1191  
Email: admin@absco.com.au

Date of issue: 19 December 2018

## Details of Manufacturer's Warranty

This product comes with a Lifetime structural warranty from the date of purchase. This warranty also applies where there are missing or damaged parts identified in the parts list referred to in the instruction kit within the product packaging.

Please ensure that you keep this warranty form in a safe place along with your proof of purchase. You can register your warranty online <http://absco sheds.com.au/warranty-details/> or complete the form on the back of this document and mail it back to Absco, along with a copy of your proof of purchase.

The benefits of this warranty are in addition to your rights under the Australian Consumer Law (ACL) and in particular, the guarantees implied under the ACL and any other rights and remedies of the consumer under a similar law in relation to the goods and services to which this warranty relates.

## Process of claiming warranty:

To make a claim under the warranty within the warranty period, you will need to contact the manufacturer directly by phone or email:

Contact Number: 1800 029 701  
Contact Email: admin@absco.com.au

You will be required to produce proof of purchase (this is at discretion of the manufacturer) at the time of the claim.

The manufacturer bears the cost of replacing the products or spare parts or repairing the products and reasonable direct expenses of claiming under this warranty:

Where parts are replaced, the manufacturer will bear the cost of sending the spare part and will endeavour to deliver it to the customer's nearest reseller within 20 working days for the customer to pick up. At such time the customer may be required to return the alleged faulty parts.

Where assessment is required in case of replacing or repairing the product, the manufacturer will appoint an assessor within 10 working days to identify the alleged defect. The manufacturer will bear the repair costs by appointing a local tradesman. The manufacturer may choose to replace the product if the repair or the cost of repair is not feasible. The replacement product will be available for collection from the nearest reseller within 20 working days. The customer will bear the cost of assembly for the replacement product.

**IMPORTANT**

**1. Manufacturer's Disclosure**

This warranty against defects shall not apply in the following situations:

- A) Where the product is not assembled in accordance with the instructions provided in the product kit;
- B) Where the product is used to store corrosive materials such as fertilizer, chlorine etc;
- C) The warranty does NOT cover damage caused by storms, wind, rain, snow or poor foundations;
- D) This warranty does not apply to surface deterioration of panels caused by 'Swarf' (Tiny particles of steel debris left from cutting, grinding or drilling operations) that has not been removed after building construction.

**2. Notes**

This product is weatherproof to a certain level; however driving windy rain may cause the product to leak. Condensation may also occur in some weather conditions such as extreme heat or cold. The product should only be used for storing items such as gardening equipment and should not be used for articles that may be prone to damage if they come into contact with moisture.

**3. Major Defects**

If the manufacturer is satisfied that the defect is a major defect, the purchase price may be refunded in lieu of providing a replacement product or repairing the product.

This warranty is provided in addition to other rights and remedies you have under law: Our goods come with guarantees which cannot be excluded under the Australian Consumer Law. You are entitled to replacement or refund for a major failure and to compensation for other reasonably foreseeable loss or damage. You are also entitled to have the goods repaired or replaced if the goods fail to be of acceptable quality and the failure does not amount to a major failure.

**If you do not wish to register your warranty online, complete the below form and email, fax or post this form back to Absco, along with a copy of your proof of purchase.**

**NAME:** \_\_\_\_\_

**STREET ADDRESS:** \_\_\_\_\_

**POSTAL / ZIP CODE:** \_\_\_\_\_

**STATE / CITY / PROVINCE / REGION:** \_\_\_\_\_

**COUNTRY:** \_\_\_\_\_

**SHED TYPE/CODE:** \_\_\_\_\_

**ORDER NO:** \_\_\_\_\_

**DATE OF PURCHASE:** \_\_\_\_\_

**EMAIL ADDRESS:** \_\_\_\_\_

**DATE REGISTERED:** \_\_\_\_\_

