

For construction in non-cyclonic areas
Wind rating: N2 as per AS4055-2021.
If you require a higher wind rating please contact
us: admin@absco.com.au or 1800 029 701

NOTE: This shed can be upgraded to wind
rating: C1 as per AS4055-2021 with the additional
purchase of a Cyclone Kit.

When laying concrete slab, ensure there
is a rebated edge 25mm deep around
the perimeter. This will help water egress
from the base of the shed.

PLEASE LEAVE A REVIEW

Tell us about your experience!
Visit www.absco.sheds.com.au/review

GENERAL INSTRUCTIONS

- Before commencing any assembly, read through these instructions in detail to gain a thorough understanding of assembly methods and associated details.
- Unpack the carton and carefully identify and check off all the parts against the parts described and illustrated on "COMPONENTS PACKING LIST" pages.
- Local authority approval must be obtained prior to construction of the shed. Once you have selected your site you will need to lodge a site plan to your local council.

SITE PREPARATION

- The site for the shed must be level. An uneven surface may result in misalignment of parts.
- The shed shall be erected on top of a reinforced concrete slab and anchored down appropriately illustrated on "FINAL CONSTRUCTION" page. **If using a rebated slab ensure that all frame uprights are trimmed 25mm.**

TOOLS REQUIRED

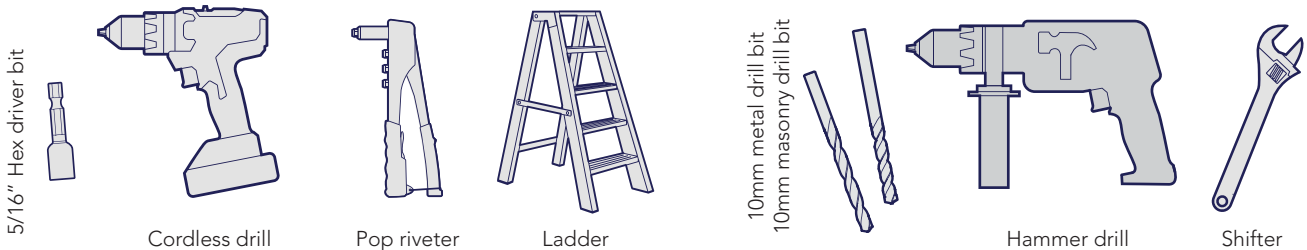

SAFETY NOTES

- Some parts may have sharp edges. It is advisable to wear gloves when handling these items and safety glasses if drilling holes. Sensible shoes are highly recommended.
- Do not erect your shed in windy conditions.
- It is highly recommended to erect the shed with two or more people.
- Do not sit, stand or walk on the roof of your shed.

RECOMMENDED







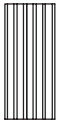
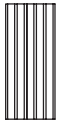
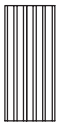
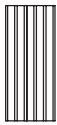
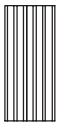
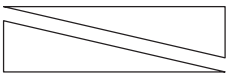
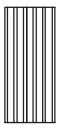
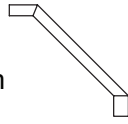
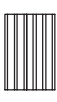
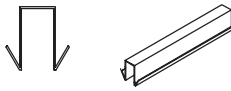
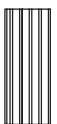
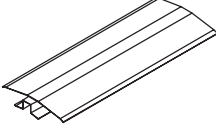
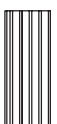
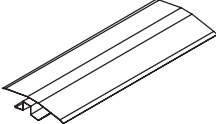









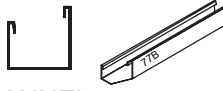



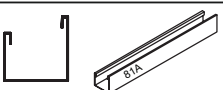

COMPONENT PACKING LIST

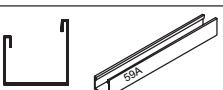
Check off all components.

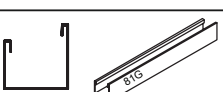

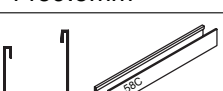





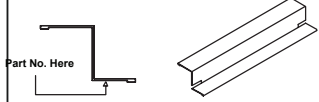
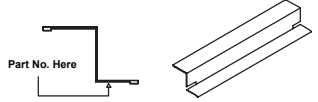
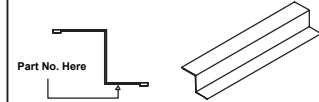
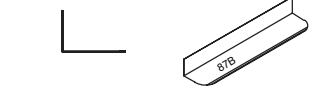
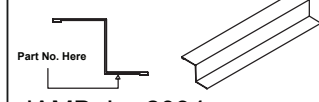
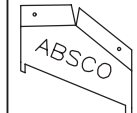

MAIN PACK CARTON (PACK 1 OF 2)							
QTY	COMPONENT DESCRIPTION	PART No.	CHECK	QTY	COMPONENT DESCRIPTION	PART No.	CHECK
2	 STEEL SHEET 2034mm X 773mm	H30		1	 STEEL SHEET 1974mm X 773mm	F	
6	 STEEL SHEET 2034mm X 773mm	H31		1	 STEEL SHEET 1974mm X 773mm	E	
2	 STEEL SHEET 1546mm X 773mm	44L		2	GABLES R/H&L/H L=1475mm 	16R 16L	
2	 STEEL SHEET 1546mm X 773mm	44R		2	BRACE L: 393mm 	13A	
4	 STEEL SHEET 1546mm X 773mm	45A		1	 RIDGE BEAM JOINER L: 450mm (17.7")	ZARSP	
2	 STEEL SHEET 2034mm X 711mm	H34		1	 RIDGE BEAM L = 1521mm	97AL	
4	 STEEL SHEET 2034mm X 731mm	HRC		1	 RIDGE BEAM L = 1521mm	97AR	

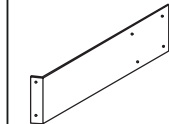
Nominal sheet widths are shown. +/- 2mm is within tolerance.

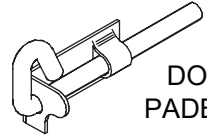
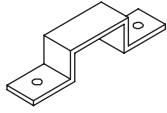
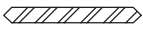





COMPONENT PACKING LIST

CHANNEL SET							
QTY	COMPONENT DESCRIPTION	PART No.	CHECK	QTY	COMPONENT DESCRIPTION	PART No.	CHECK
1	 CHANNEL L = 1496.5mm	77AL		1	 CHANNEL L = 1496.5mm	77AR	
1	 CHANNEL L = 1496.5mm	55CL		1	 CHANNEL L = 1496.5mm	55CR	
1	 CHANNEL L = 1496.5mm	77BL		1	 CHANNEL L = 1496.5mm	77BR	
2	 CHANNEL L = 1496.5mm	78AL		2	 CHANNEL L = 1496.5mm	78AR	
1	 CHANNEL L = 1496.5mm	81BL		1	 CHANNEL L = 1496.5mm	81BR	
2	 CHANNEL L = 1496.5mm	81AL		2	 CHANNEL L = 1496.5mm	81AR	
2	 CHANNEL L = 1459.5mm	59AL		2	 CHANNEL L = 1459.5mm	59AR	
2	 CHANNEL L = 1459.5mm	81GL		2	 CHANNEL L = 1459.5mm	81GR	
4	 CHANNEL L = 773mm	58C		1	 CHANNEL L = 1568mm	79A	
2	 CHANNEL WITH HINGES L = 1974mm	HC1		1	 CHANNEL L = 1974mm	HC2	

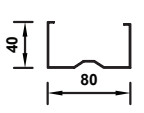
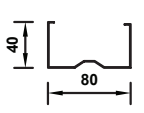
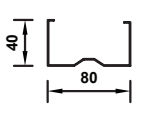
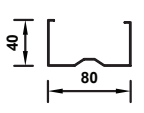
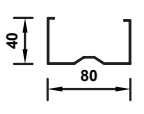
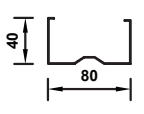
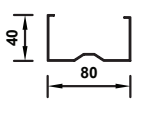
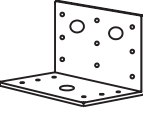
COMPONENT PACKING LIST

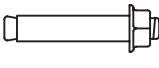
CHANNEL SET (CONTINUED)							
QTY	COMPONENT DESCRIPTION	PART No.	CHECK	QTY	COMPONENT DESCRIPTION	PART No.	CHECK
1	 JAMB L= 1568mm	90A		1	 JAMB L= 1974mm	HJ3	
4	 JAMB L= 1120mm	91A		4	 LIP TRIM L= 1546mm	87B	
2	 JAMB L= 2034mm	HJ1					
FITTINGS & ACCESSORIES PACKET CONTENTS							
1	DOUBLE DOOR KIT (DETAILED BELOW)			1	ASSEMBLY INSTRUCTIONS		
2	 CAP GABLE L: 170mm	14A		10	 HEX HD TEK SCREW W/ NEO WASHER 10-16x16mm	FAST033	
2	 DOOR STRAP L: 165mm	12A		12	 CHANNEL JOINER L= 200mm (7.9")	CSJ	
PSTKDBL - DOUBLE DOOR FITTINGS PACK							
3	 DOOR PADBOLT	FAST006		2	 DOOR PADBOLT HASP	FAST007	
1	3mm DRILL BIT 	DRILL		1	PHILLIPS DRIVER BIT 	FAST038	
1	 SELF TAPPING SCREWS PACKET CONTAINING 220			1	PACK12P SCREW PACK 12		
PACK12P - SCREW PACK 12							
8	 3/16 ROUND HEAD BOLTS & NYLOCK NUTS			12	 3.2 x 8mm BLIND POP RIVETS		
12	 3/16 COUNTERSUNK SCREWS & NUTS						

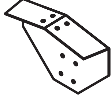
COMPONENT PACKING LIST

HIGH FRONT FRAME PACK (PACK 2 OF 2)							
QTY	COMPONENT DESCRIPTION	PART No.	CHECK	QTY	COMPONENT DESCRIPTION	PART No.	CHECK
2	 CHANNEL L = 2300mm	C2300		10	 CHANNEL L = 285mm	K0285	
2	 CHANNEL L = 2070mm	N2070		2	 CHANNEL L = 240mm	C0240	
2	 CHANNEL L = 2034mm	C2034		2	 CHANNEL L = 100mm	C0100	
2	 CHANNEL L = 1484mm	M1484		1	HIGH-FRONT FRAME FITTINGS PACK (SEE BELOW)		
HIGH-FRONT FRAME FITTINGS PACK CONTENTS							
10	 MULTI PURPOSE BRACKET MPB			1	 SMALL TRIANGULAR PLATE		
6	 10mm DYNABOLTS			150	 SELF DRILLING 16mm TEK SCREWS		
1	 RIDGE PLATES RBP			1	 SELF TAPPING SCREWS PACKET CONTAINING 100		

SNAPTITE ASSEMBLY GUIDE

The Snaptite Assembly System locks end channels to all roof and wall sheets without the need for tools and fasteners.

To assemble each panel, the perimeter channels are secured to the top and bottom of each panel. Gently tap the channel over the SNAPTITE lugs on the sheet, working along the sheet.

Each perimeter channel must finish flush with the edges of the sheets. Simply tap the channel along the sheets until each end is neatly flush. If you need to remove channels from the panels, slide it off from the side.

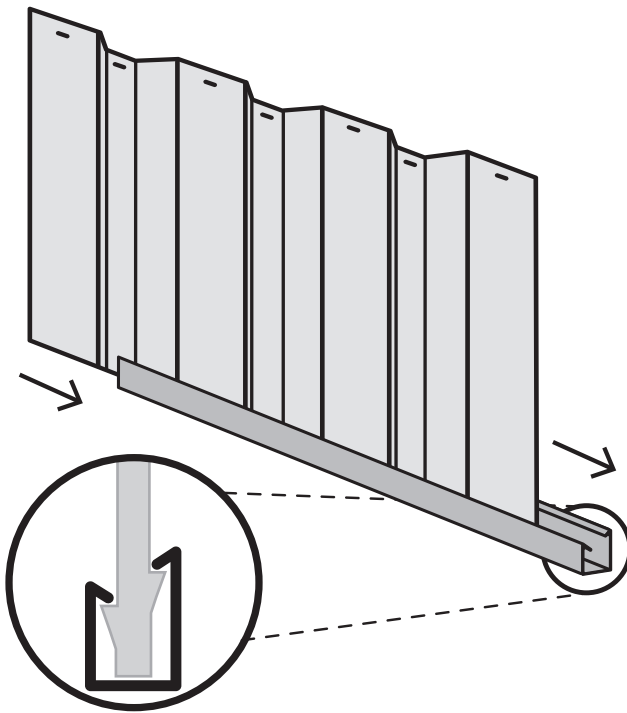

SNAPTITE
World's Easiest Assembly System
UNIQUE PATENTED SYSTEM

Channel locks the shed panel into position without the need for screws!

FASTENING SYMBOLS

 SNAPTITE

Secure channel to sheeting by SNAPTITE fastening method.



Join components together with one screw at this location only, as some channels have extra holes that are not required for this model of shed.

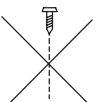

Do not join components together at this location yet, as the screws may obstruct further assembly of the other components.



Join components together by pre-drilling the holes first. Use one component as template to mark where the holes are and drill with a 3mm drill bit.



3mm pop rivet



4mm nut and bolt set.

Guide on Joining Spliced Channels

The text marked on all parts must be shown on the same side as each other



Step 1.
Position the channels and the CSJ joiner so the centre of the CSJ is in line with the end of each channel to be joined together.

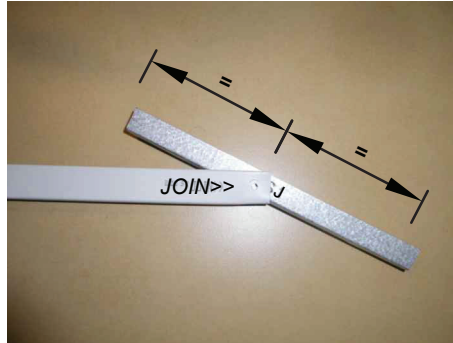

Step 2.
Join the first channel to the CSJ by inserting the centre of the CSJ, on an angle, to the end of the channel where the JOIN>> text is marked.

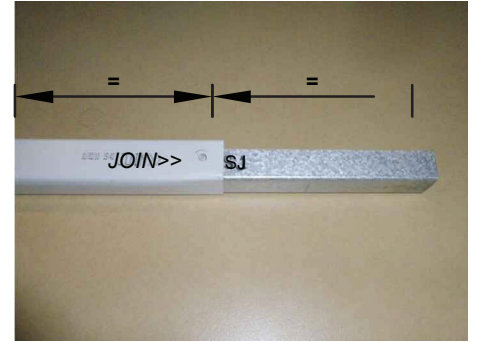

Push down one side of the CSJ until you hear a 'click'.

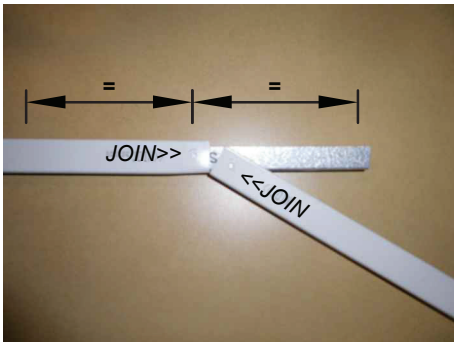

Step 3.
Join the second channel to the CSJ by positioning the <<JOIN of the channel at the centre of the CSJ, on an angle. Push the CSJ into the channel until you hear a 'click'.

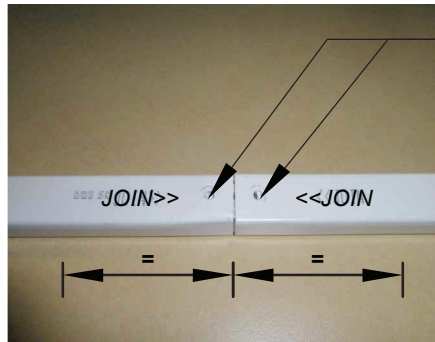

Finished Channel.
The joined channels should now look like the picture with the CSJ positioned equally inside of the joined channels.

Drill out holes with 3mm drill bit in CSJ to match the holes in channel. Drilling of screws on the joined channels is being done after sheets are locked on the spliced channels.

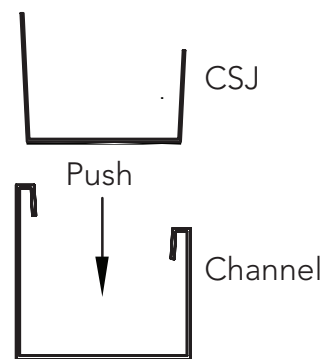

...

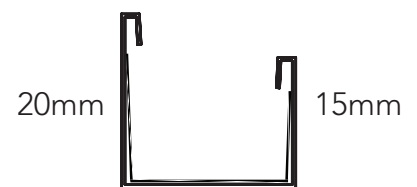

Finished Spliced Channel

PRE-ASSEMBLY OF SPLICED CHANNELS

STEP 1

Join together 20 x channel sections using 10 x channel joiners (Part CSJ)

NOTE: Some channels may have holes in them - You will need to redrill holes where CSJ joining channel covers them.

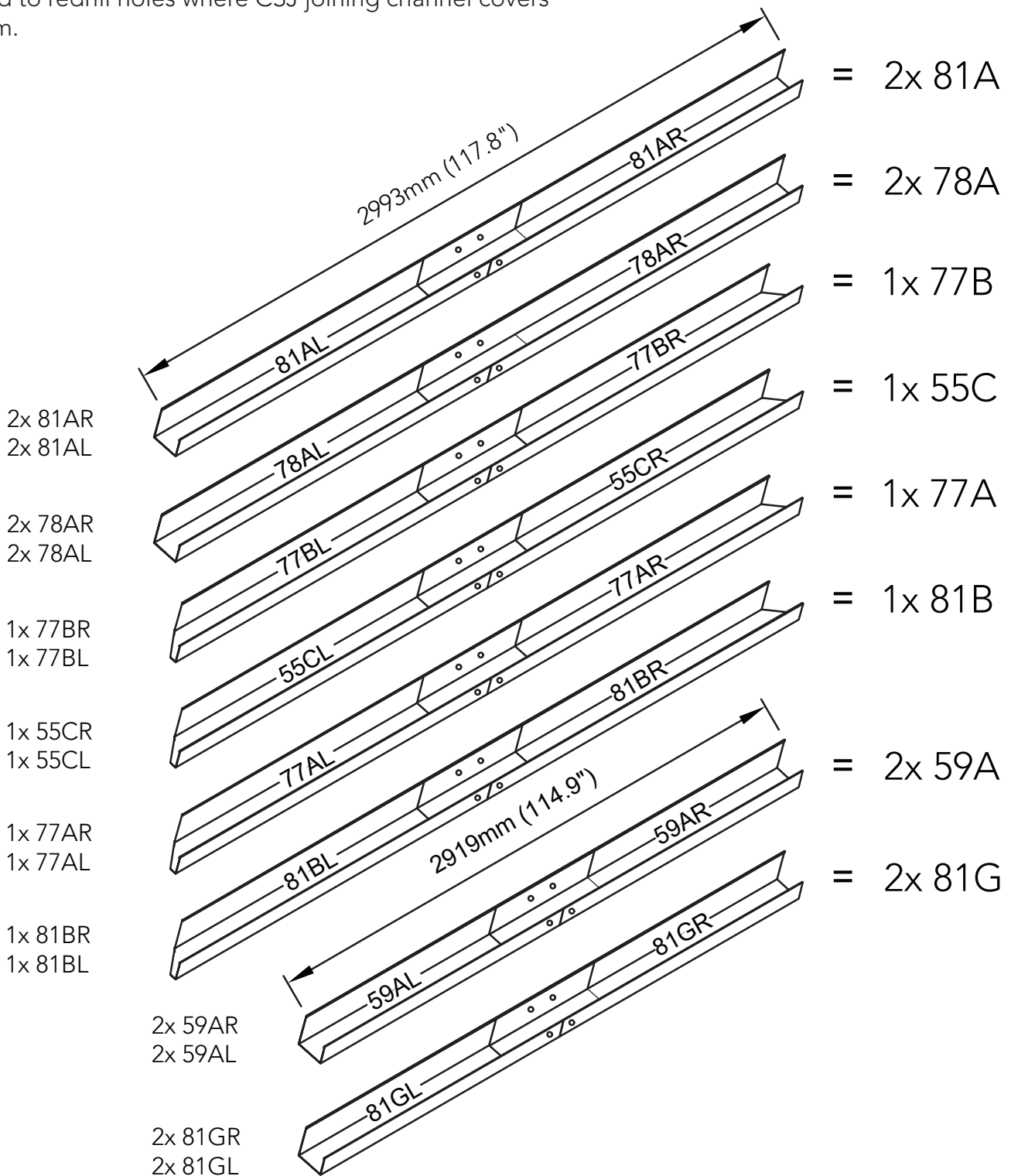

Guide on Joining a Spliced Ridge Beam

Follow these three steps to assemble a ridge beam.

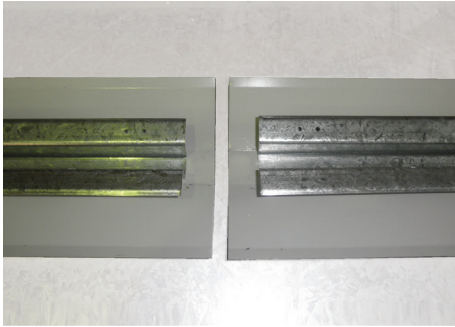

Step 1.
Place two ridge beams as shown and push them together. Slide the cap of one under the other.

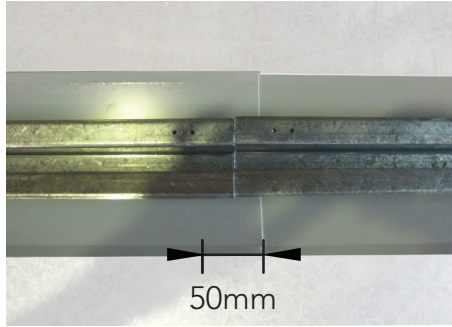

NOTE.
There is a 50mm overlap of the ridge caps when the beams are in position.

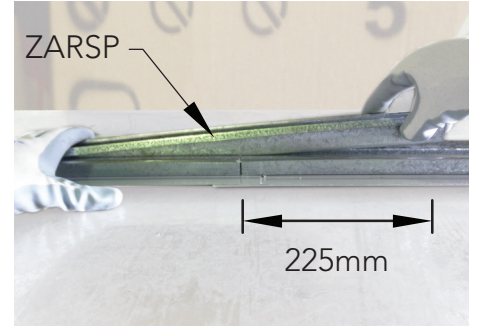

Step 2.
Use the ZARSP to connect at the centre of the two ridge beams. Be sure it is pushed in fully.

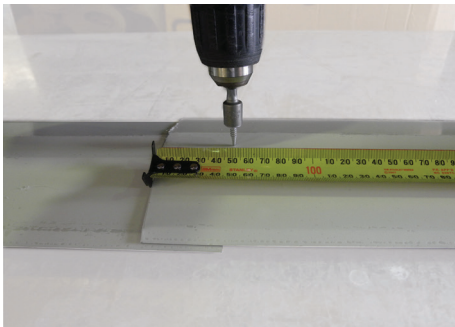

Step 3.
Turn over the ridge beam. Measure 250mm from the middle along the centre of one ridge beam, mark spacings of 50mm. Fasten with a Tek screw at each marking.

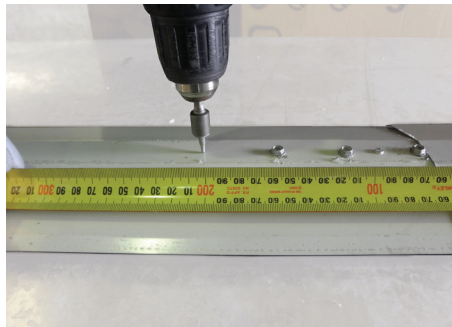

Repeat to the other side of the ridge beam assembly.

TIP: Pre-drilling each hole with the 3mm drill bit makes it easier to fasten.

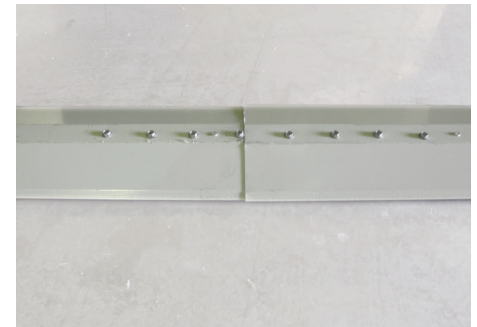

Finished Spliced Ridge Beam



Hex Driver Bit



Hex Hd Self-drilling tek screw with neoprene washer

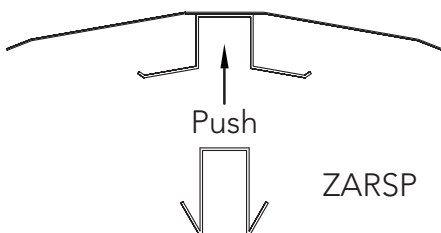

ZARSP

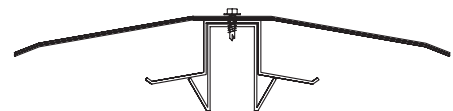

Finished
Joined Ridge Beams

PRE-ASSEMBLY OF SPLICED RIDGE BEAM

STEP 2

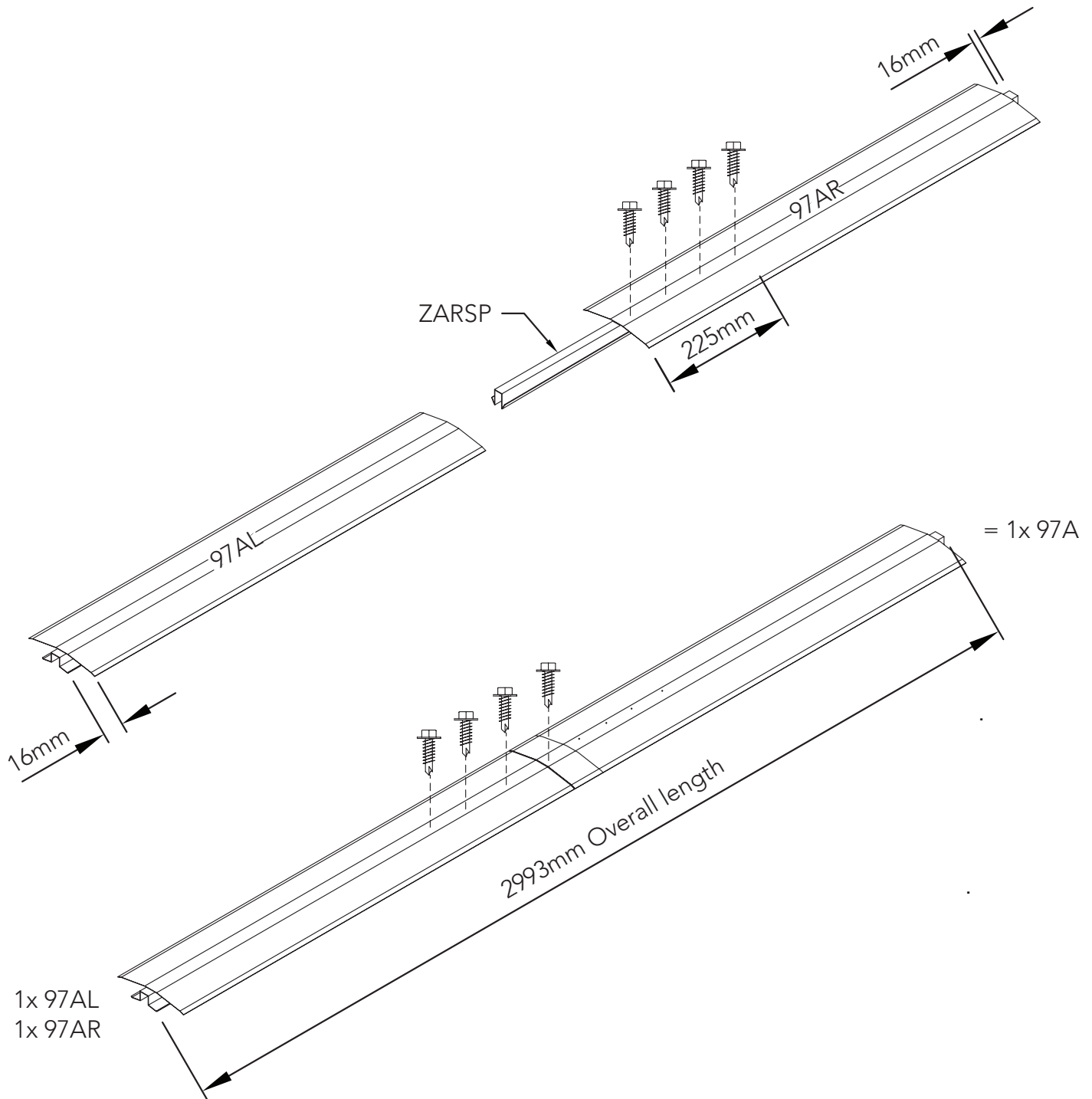

OVERVIEW OF ROOF COMPONENTS

OVERVIEW OF ROOF COMPONENTS

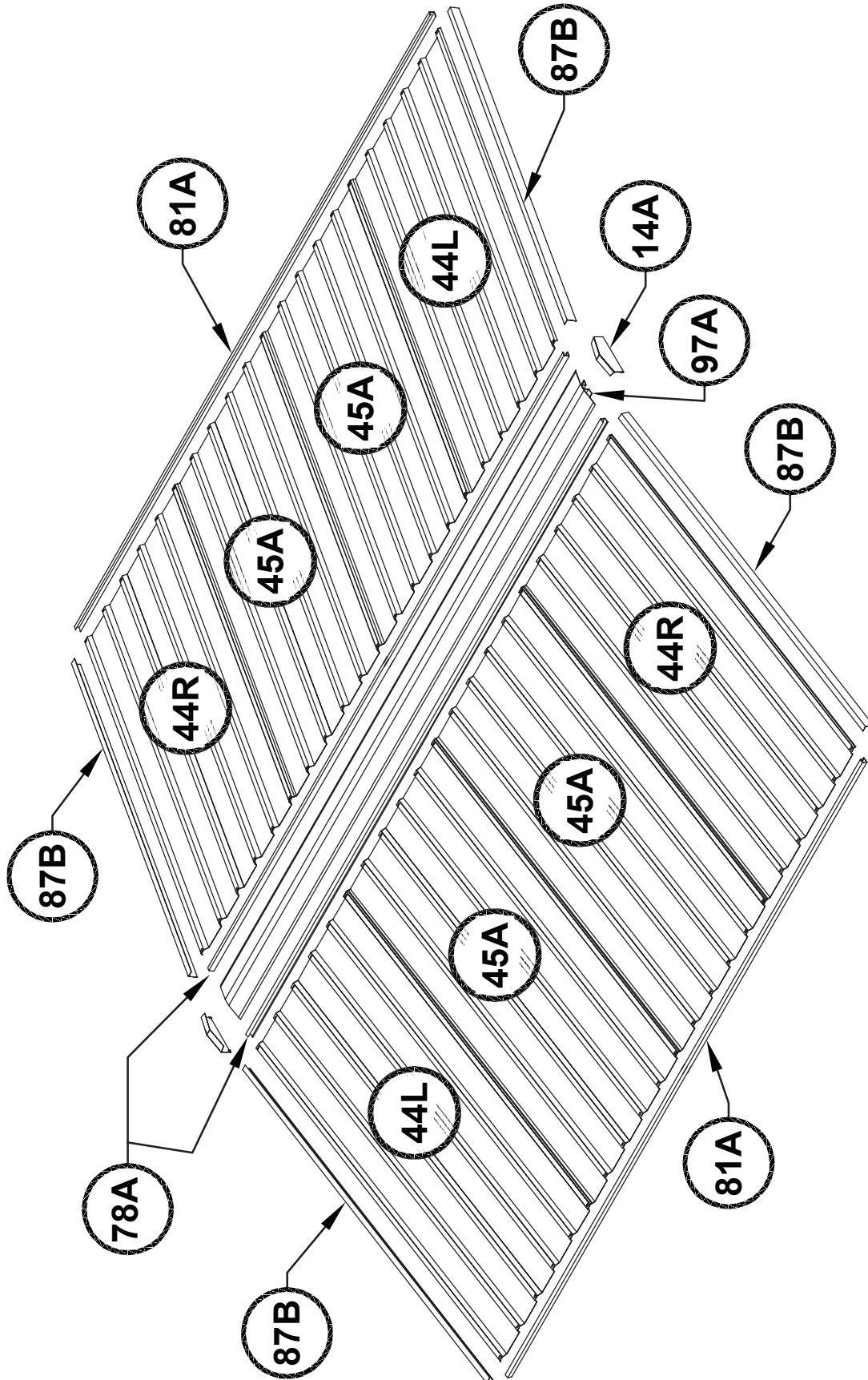

OVERVIEW OF WALL COMPONENTS

OVERVIEW OF WALL COMPONENTS

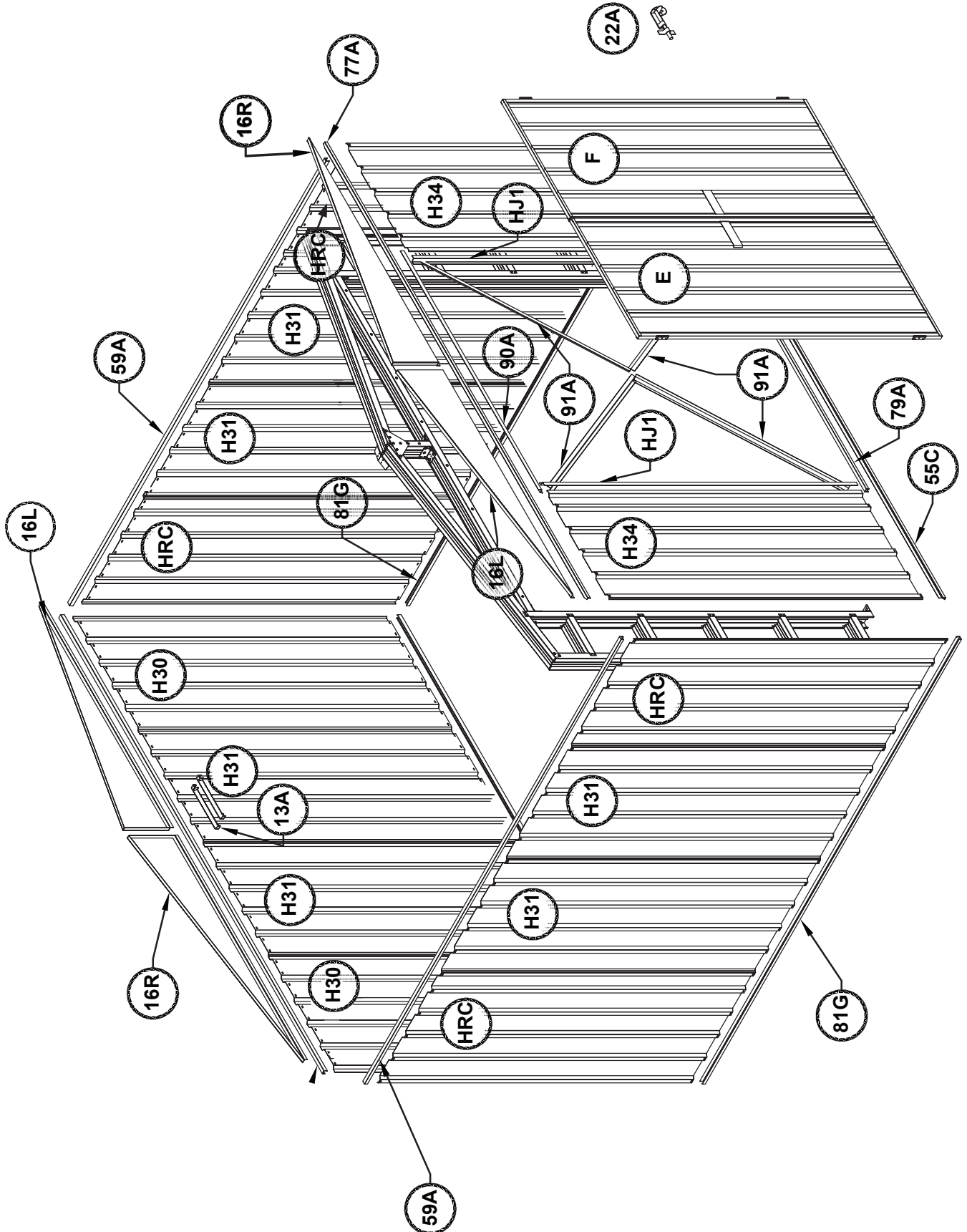

ROOF PANEL ASSEMBLY

STEP 3

2 required.

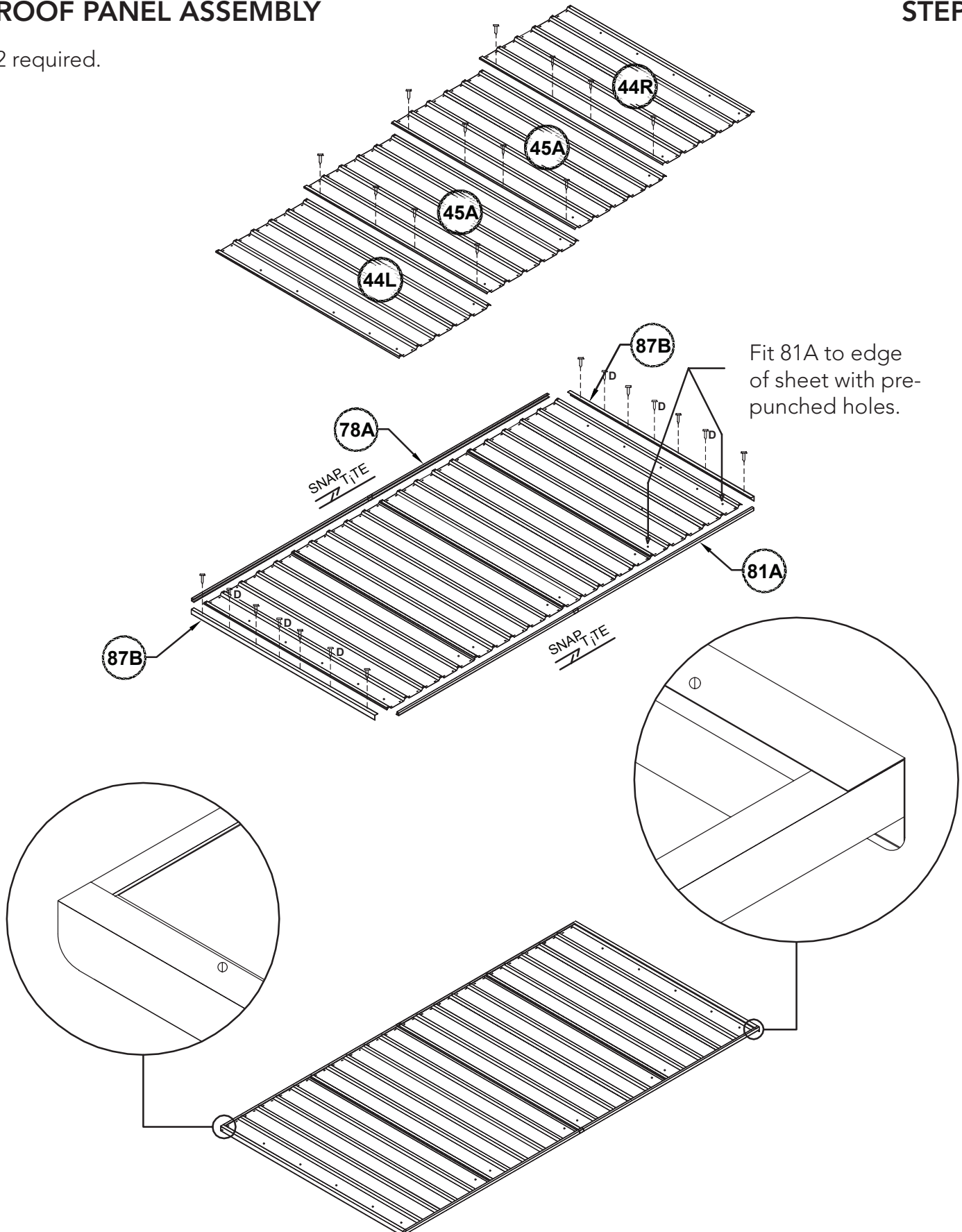

SIDE PANEL ASSEMBLY

STEP 4

2 required.

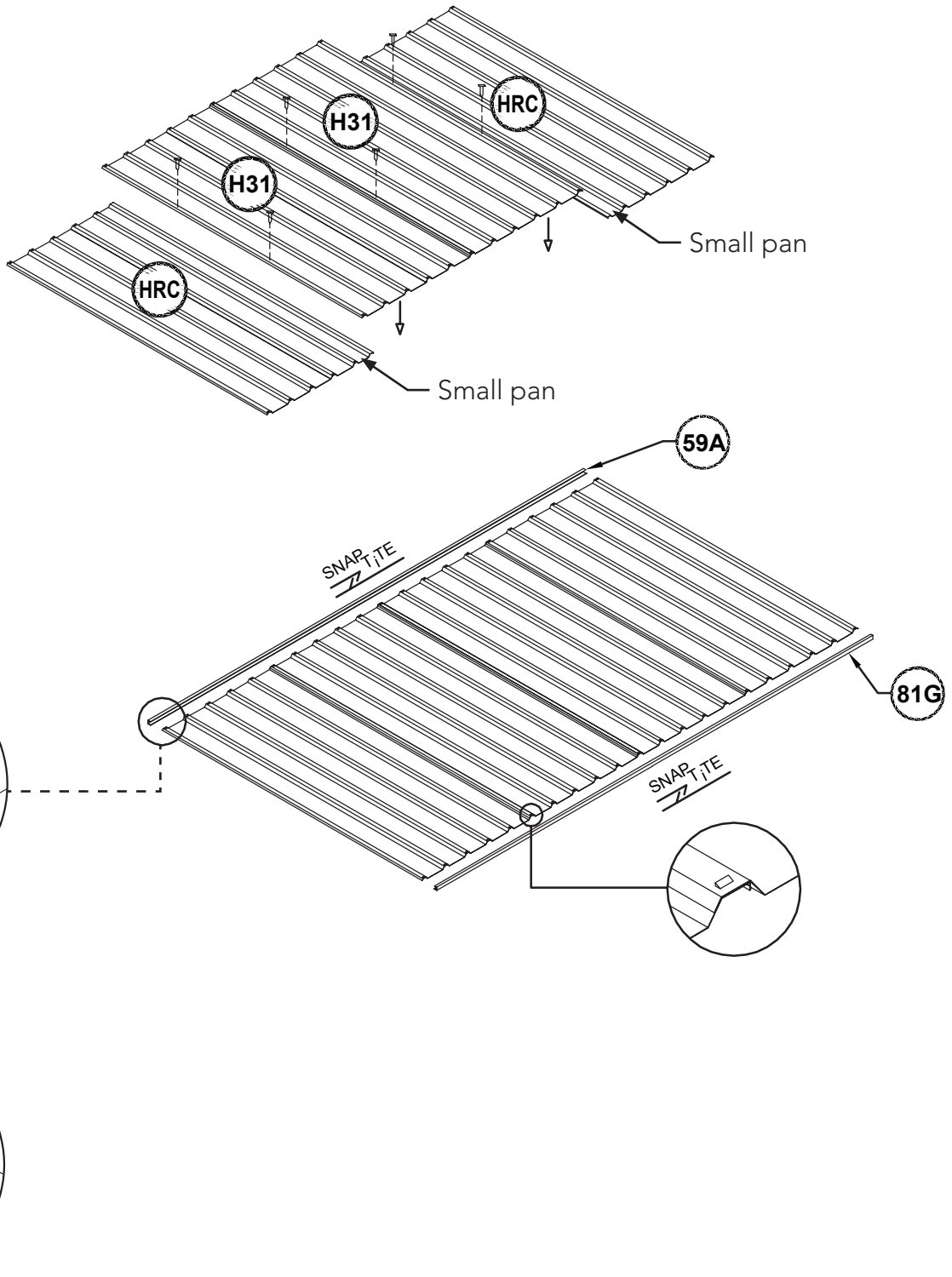

FRONT PANEL ASSEMBLY

STEP 5

1 required.

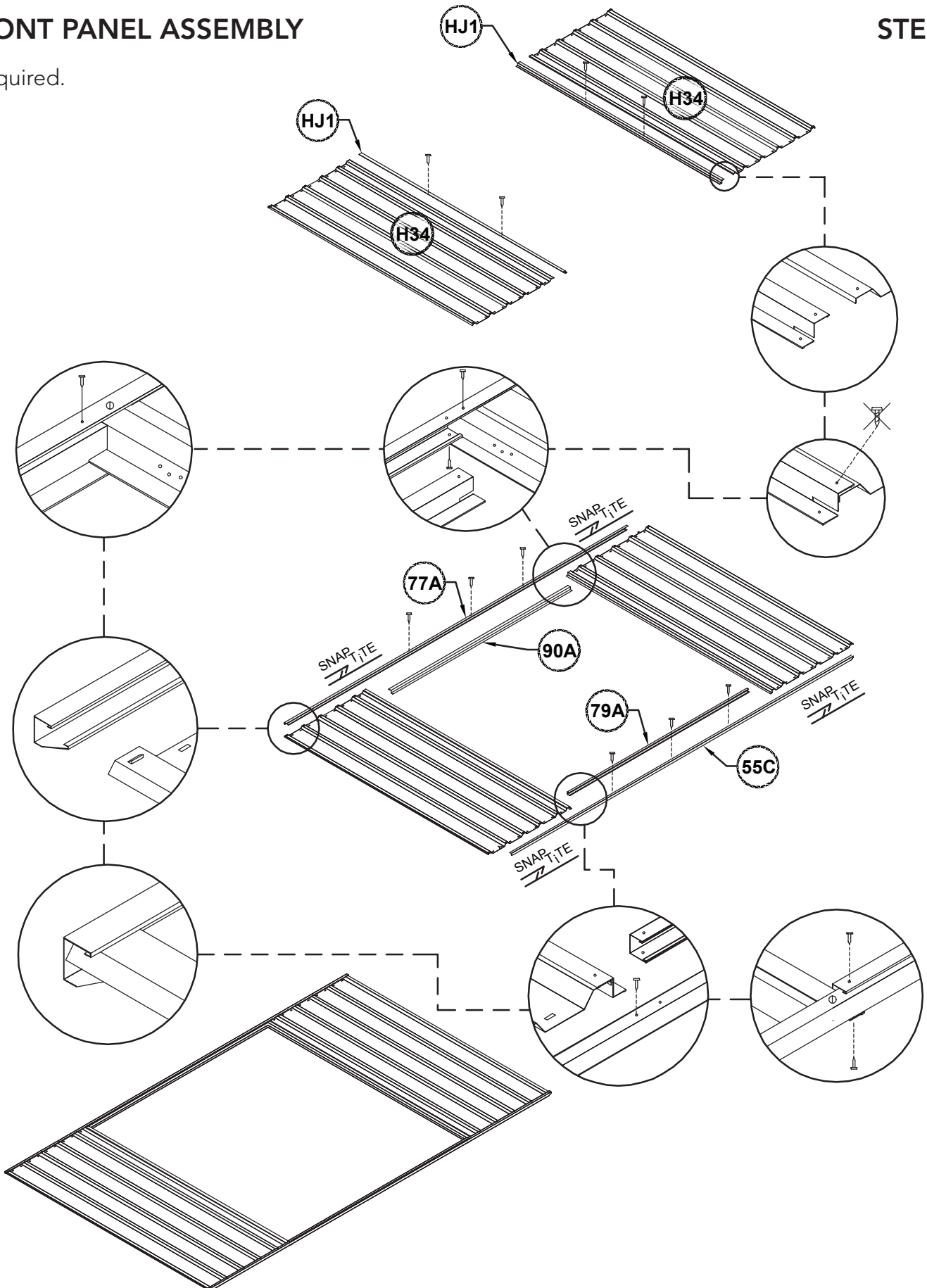

FRONT PANEL ASSEMBLY DOUBLE DOOR

1 required.

STEP 6

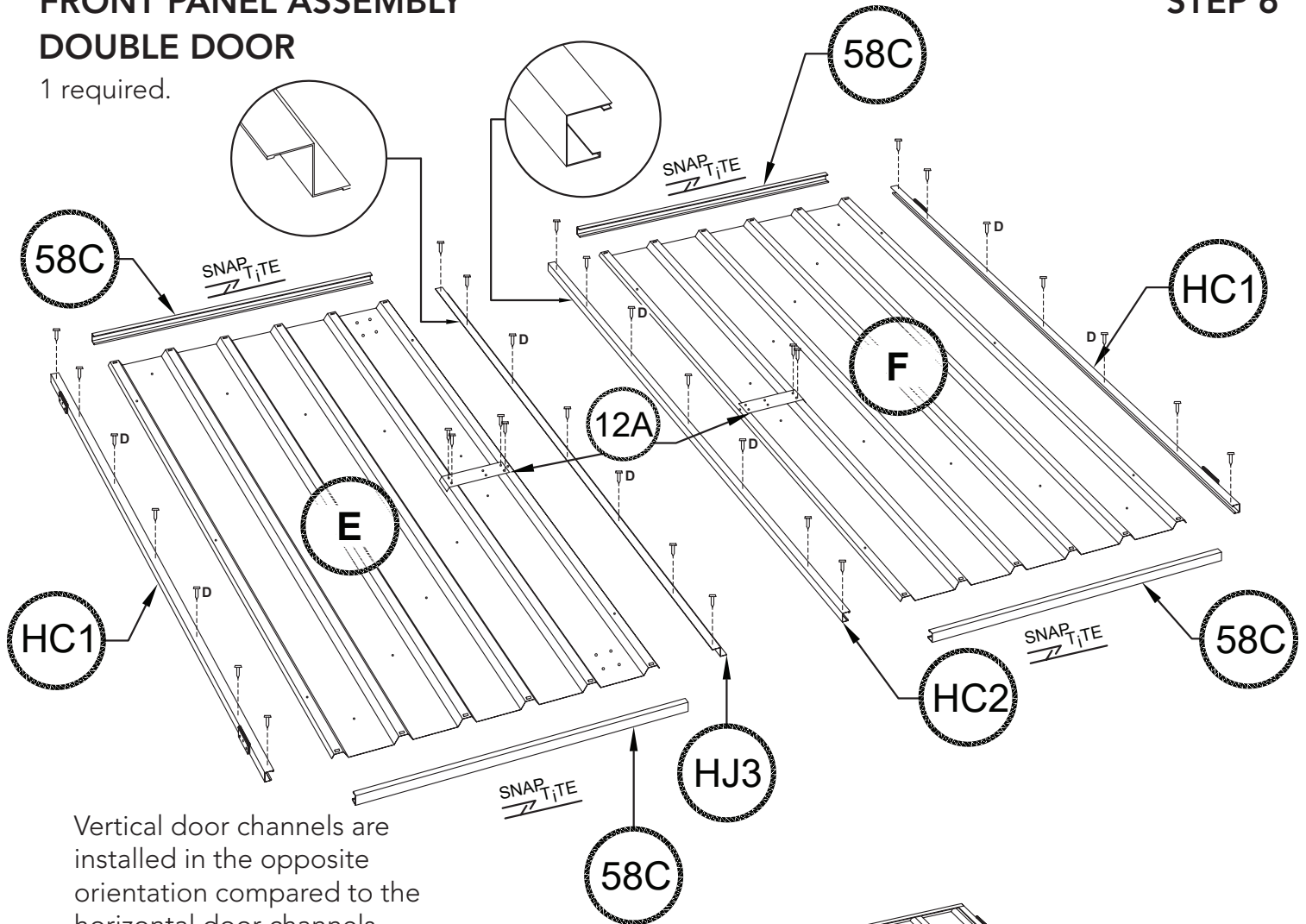

Vertical door channels are installed in the opposite orientation compared to the horizontal door channels.

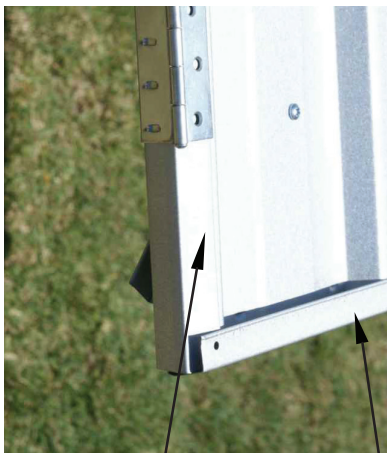

Long flange of channel

Short flange of channel

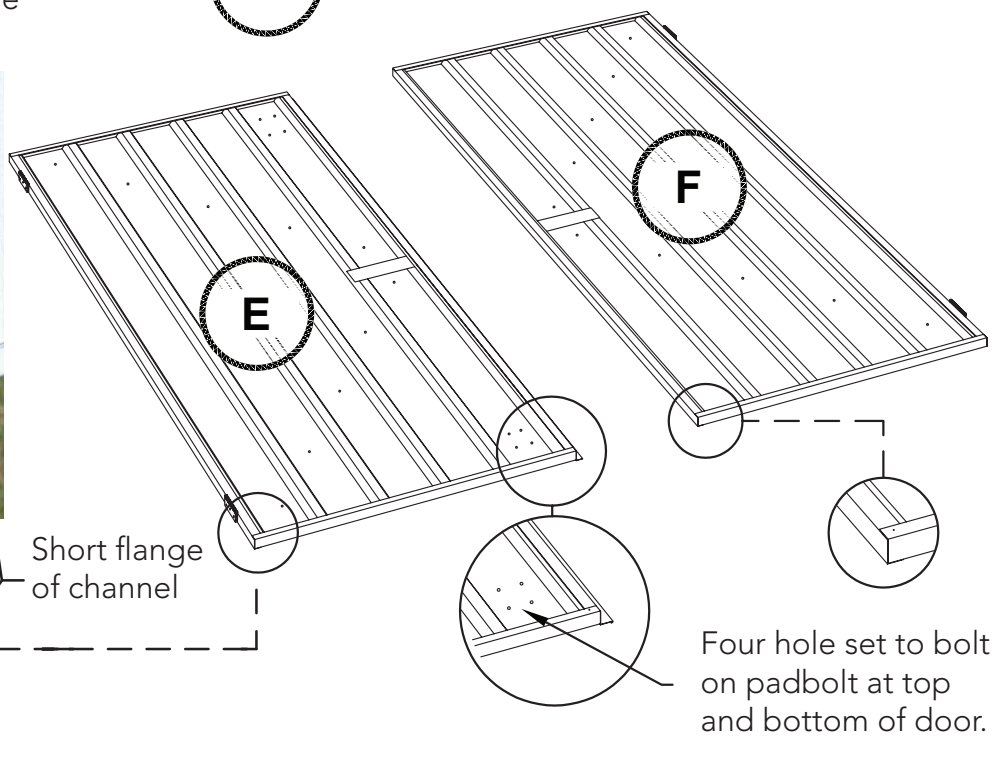
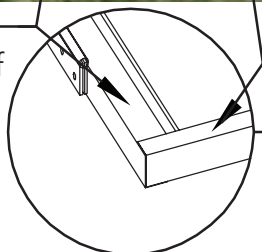

Four hole set to bolt on padbolt at top and bottom of door.

DOOR PANEL ASSEMBLY

STEP 7

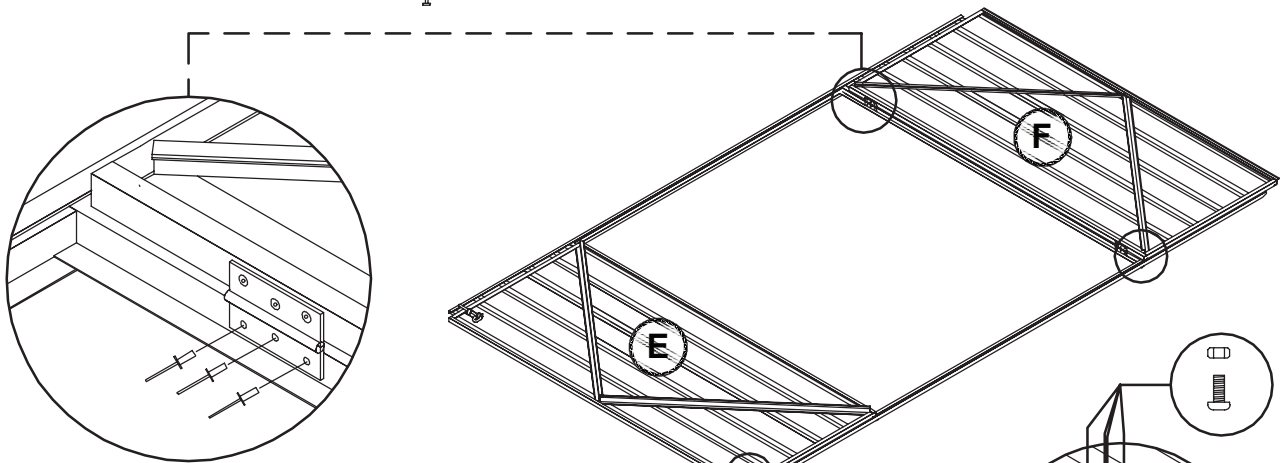
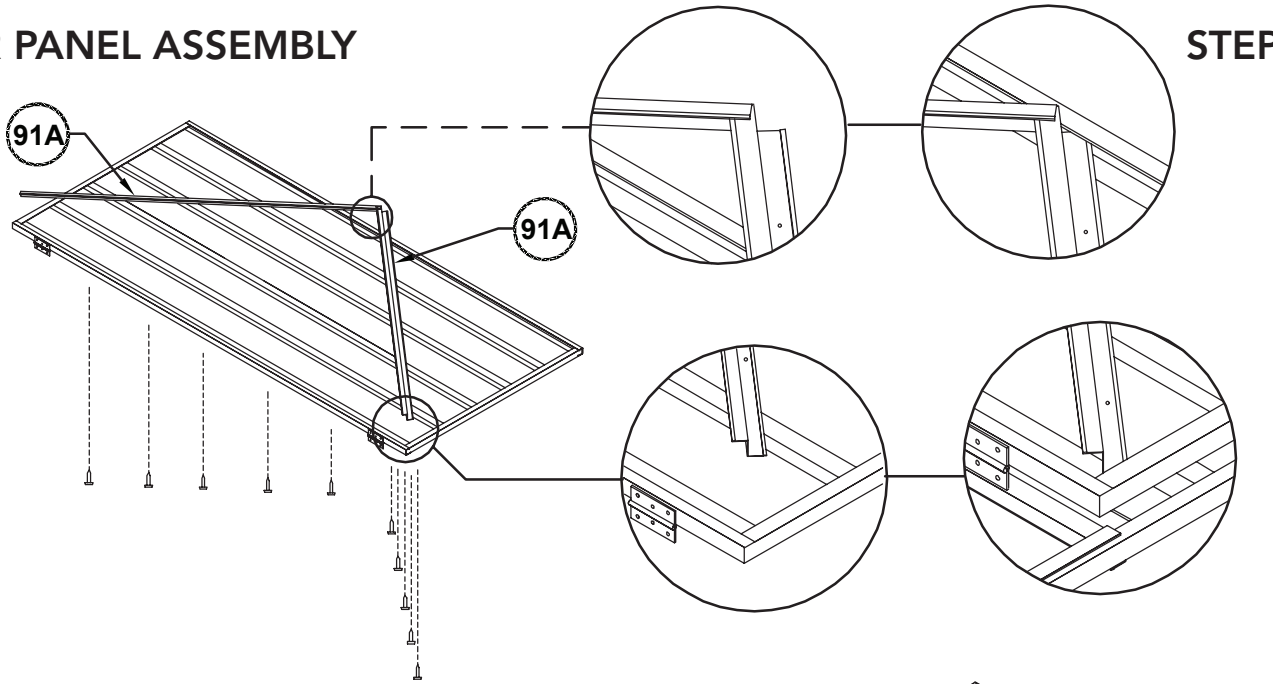

Nuts and bolts may be used instead of pop rivets by drilling out hinge holes using a 4mm drill bit. Both are supplied.

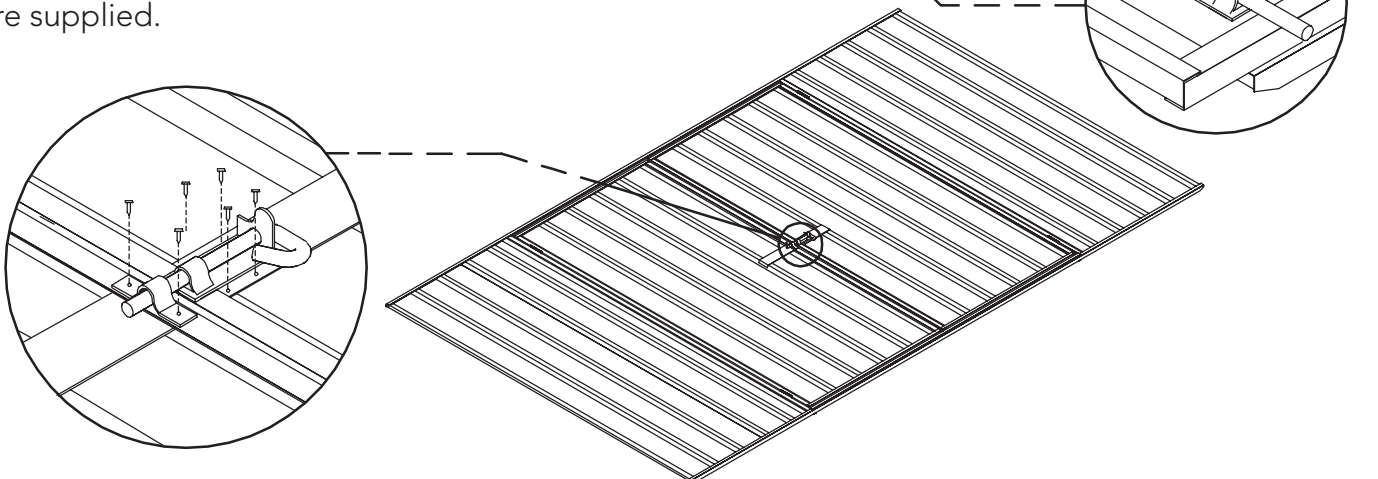

The two holes required to connect the padbolt hasp for each door have not been pre-punched, to allow for proper alignment, position each hasp centrally over the padbolt shaft and drill 3mm holes and secure with screws.

END PANEL ASSEMBLY

STEP 8

1 required.

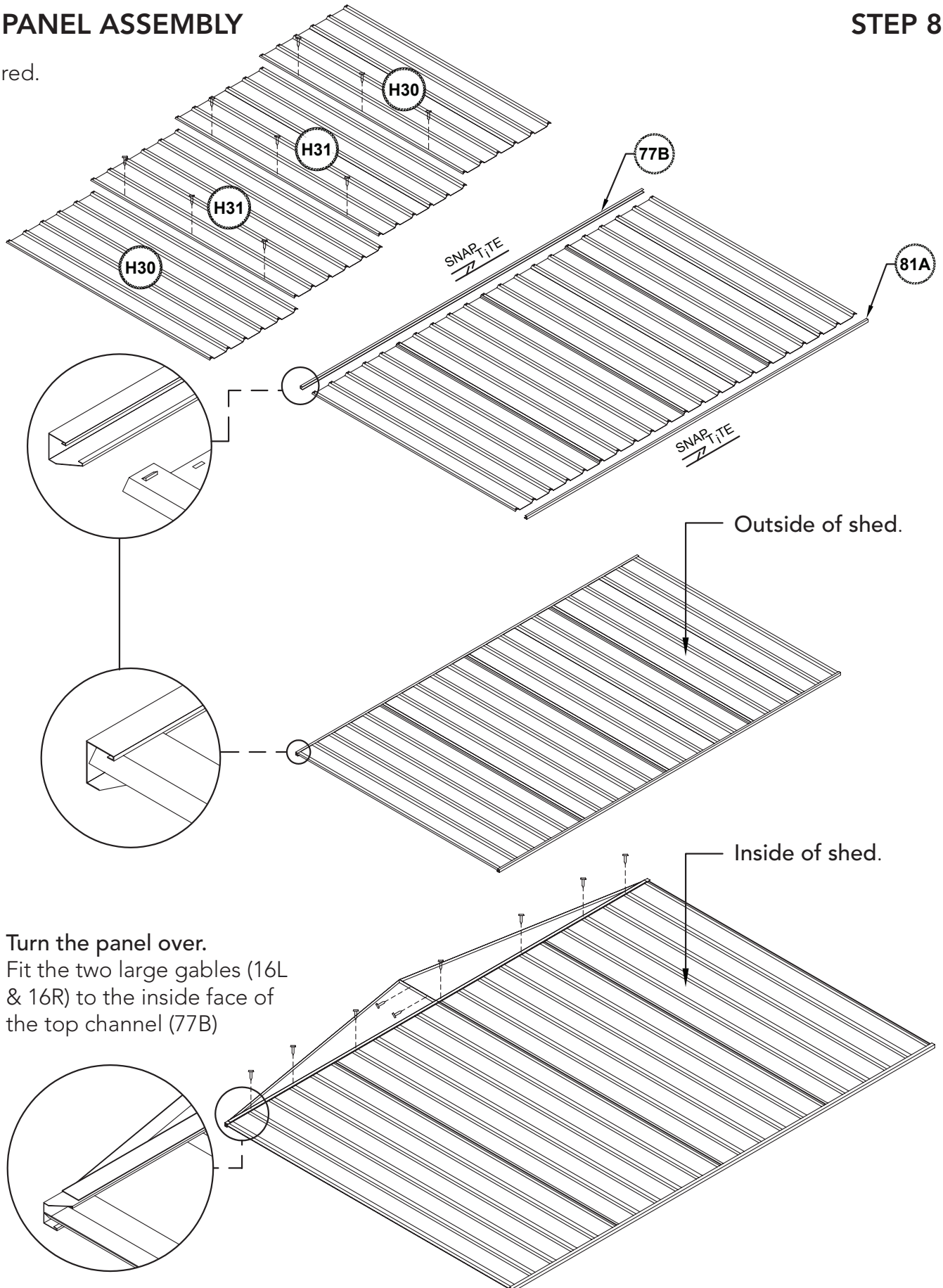

Turn the panel over.
Fit the two large gables (16L
& 16R) to the inside face of
the top channel (77B)

HIGH FRONT FRAME ASSEMBLY

STEP 9

STEP 1 of 2

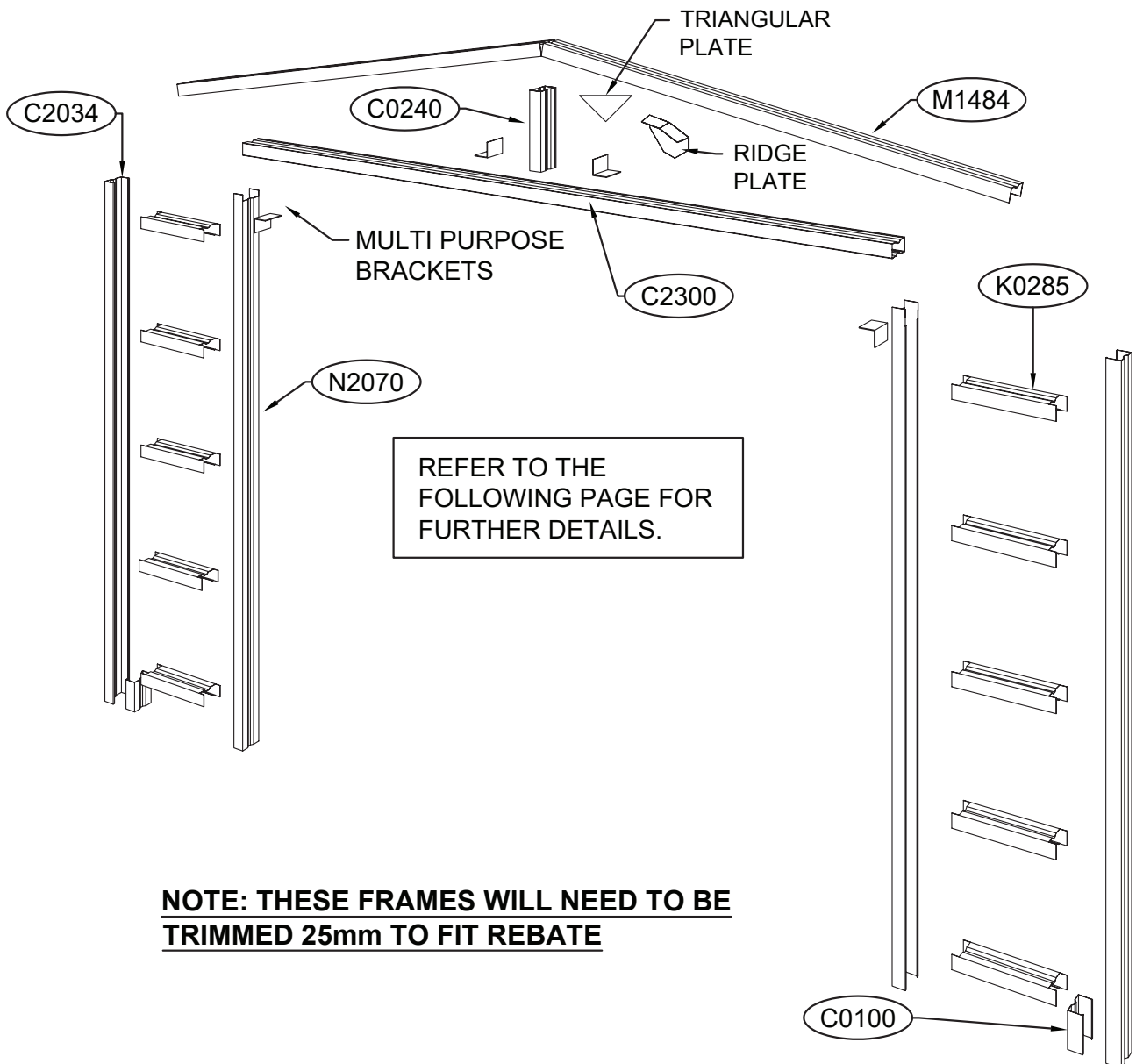
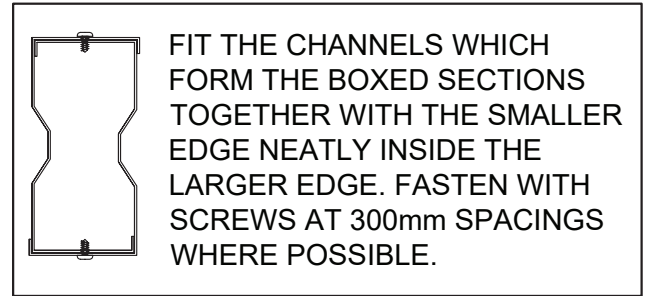
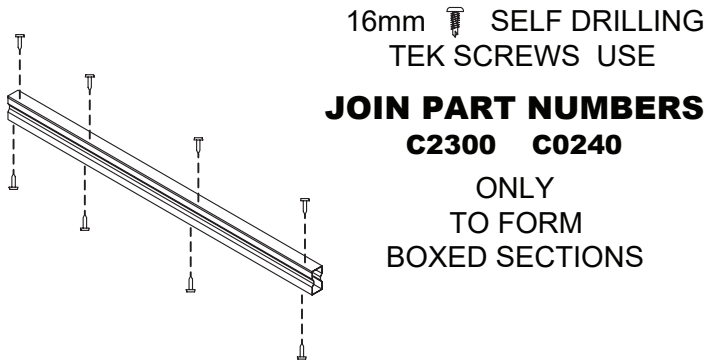

NOTE: THESE FRAMES WILL NEED TO BE TRIMMED 25mm TO FIT REBATE

HIGH FRONT FRAME ASSEMBLY

STEP 2 of 2.

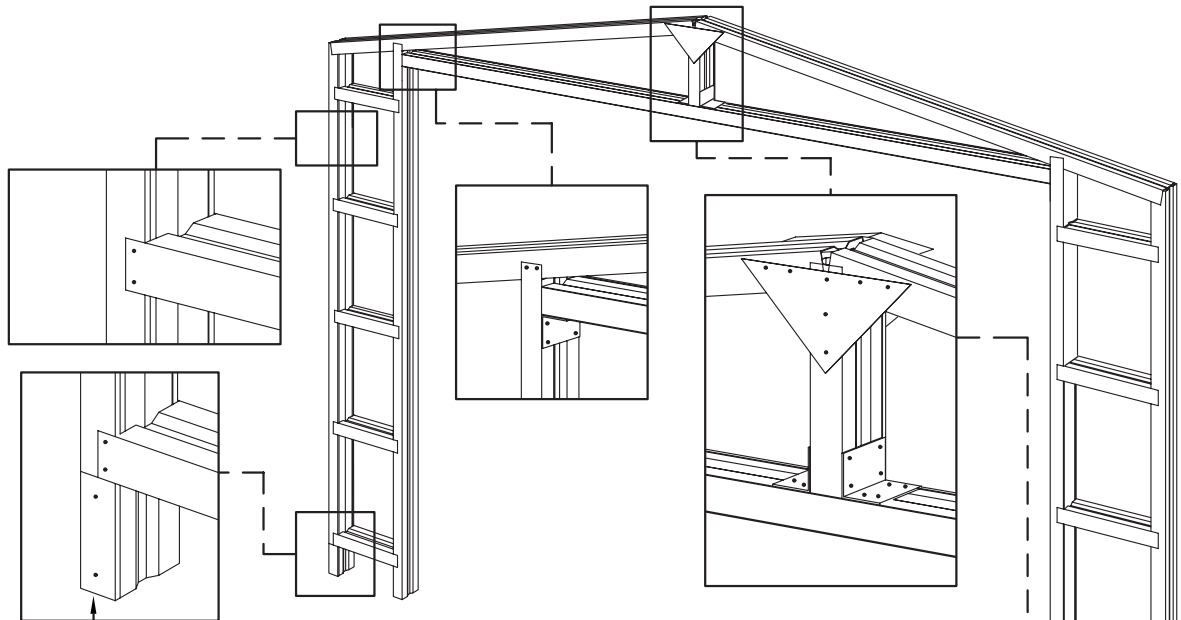

FIT ONE 100mm CHANNEL SECTION (C0100) TO BOX THE BASE OF EACH OUTSIDE LEG AS SHOWN. THESE WILL LATER BE USED FOR SECURING THE FRAME TO THE CONCRETE SLAB.

SECURE THE SMALL TRIANGULAR PLATE TO THE EXTERIOR SIDE OF THE FRAME.

SECURE THE RIDGE PLATE TO THE INTERIOR SIDE OF THE FRAME.

40mm ALL SECTIONS

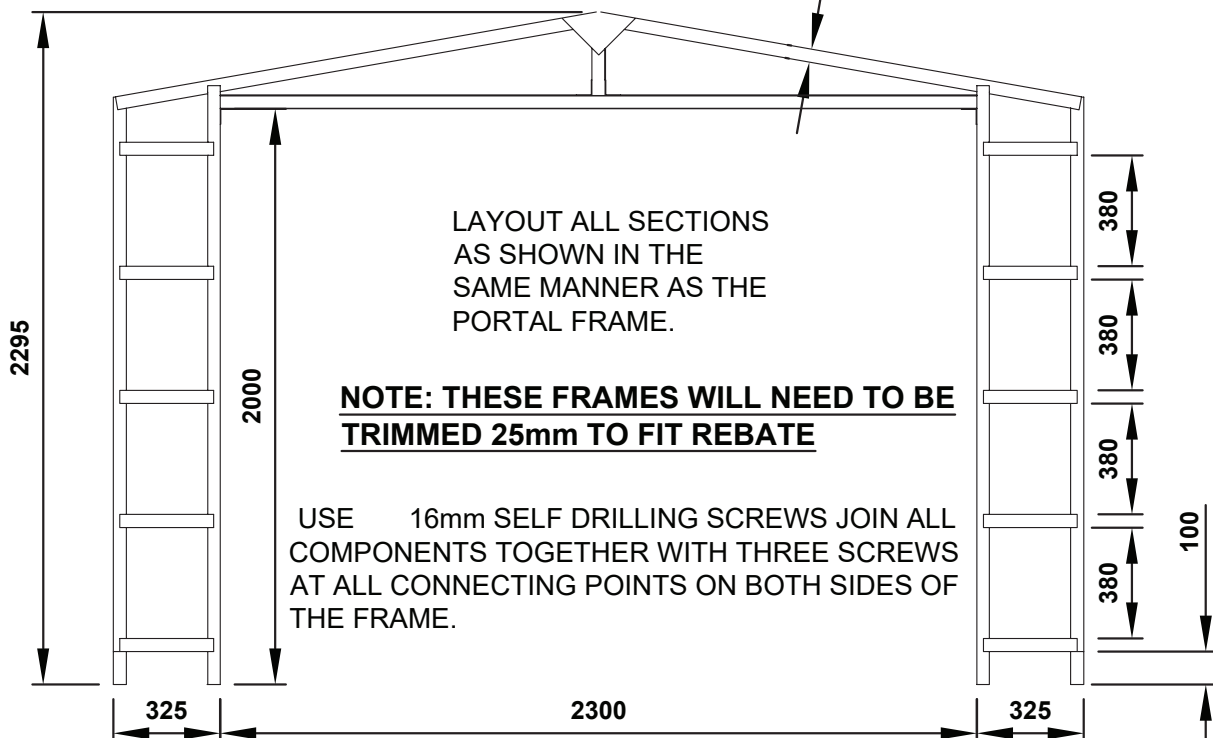

NOTE: IF YOU HAVE AN EDGE REBATE IN YOUR CONCRETE SLAB, YOU WILL HAVE TO CUT AN AMOUNT OFF THE BOTTOM OF THE FRAME LEGS EQUAL TO THE DEPTH OF THE REBATE.

HIGH FRONT FRAME ASSEMBLY SUPPORT PHOTOS

STEP 1.

Draw pattern on the concrete in accordance with the dimensions detailed in the assembly instructions.

Step 1a

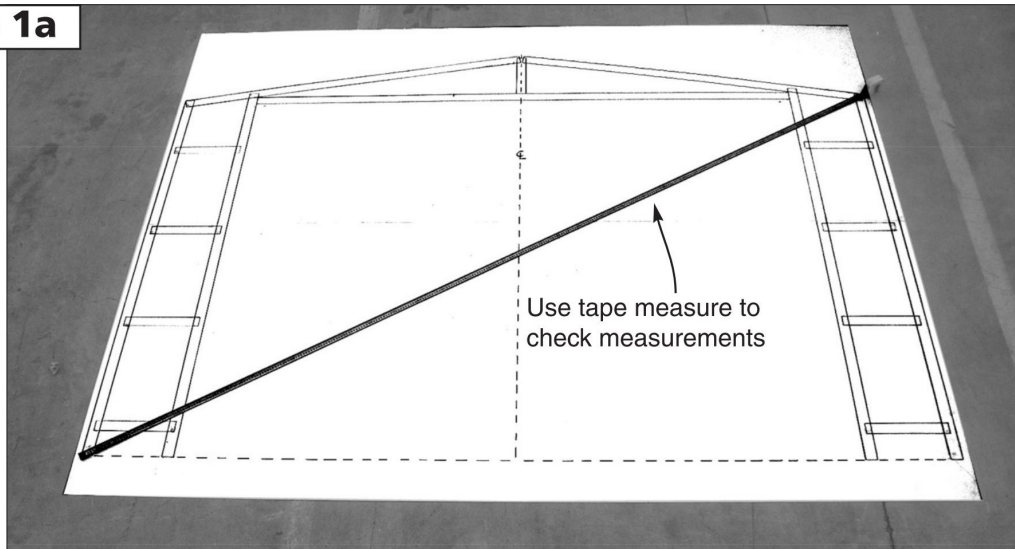

Step 1b

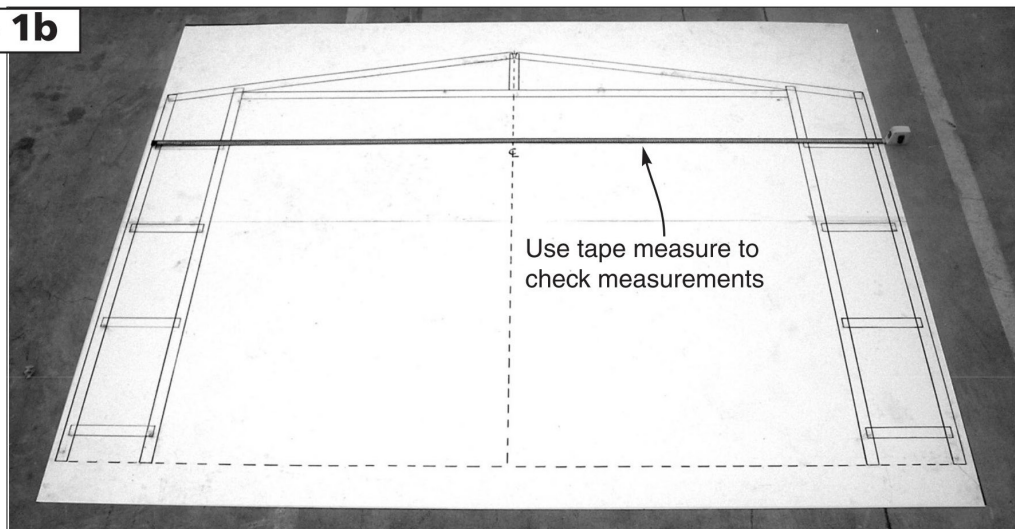

Step 1c

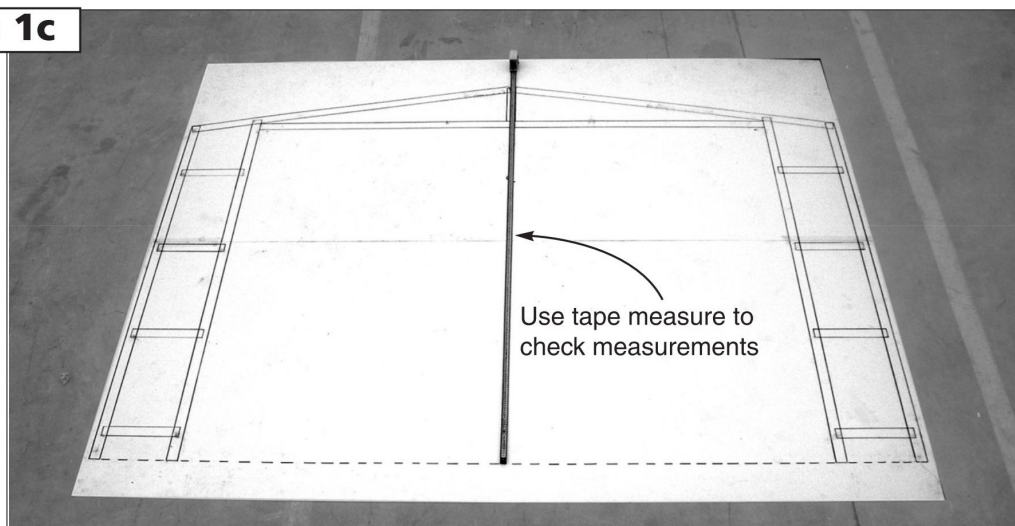

HIGH FRONT FRAME ASSEMBLY SUPPORT PHOTOS

STEP 2.

Understand where components are to be positioned.

Step 2

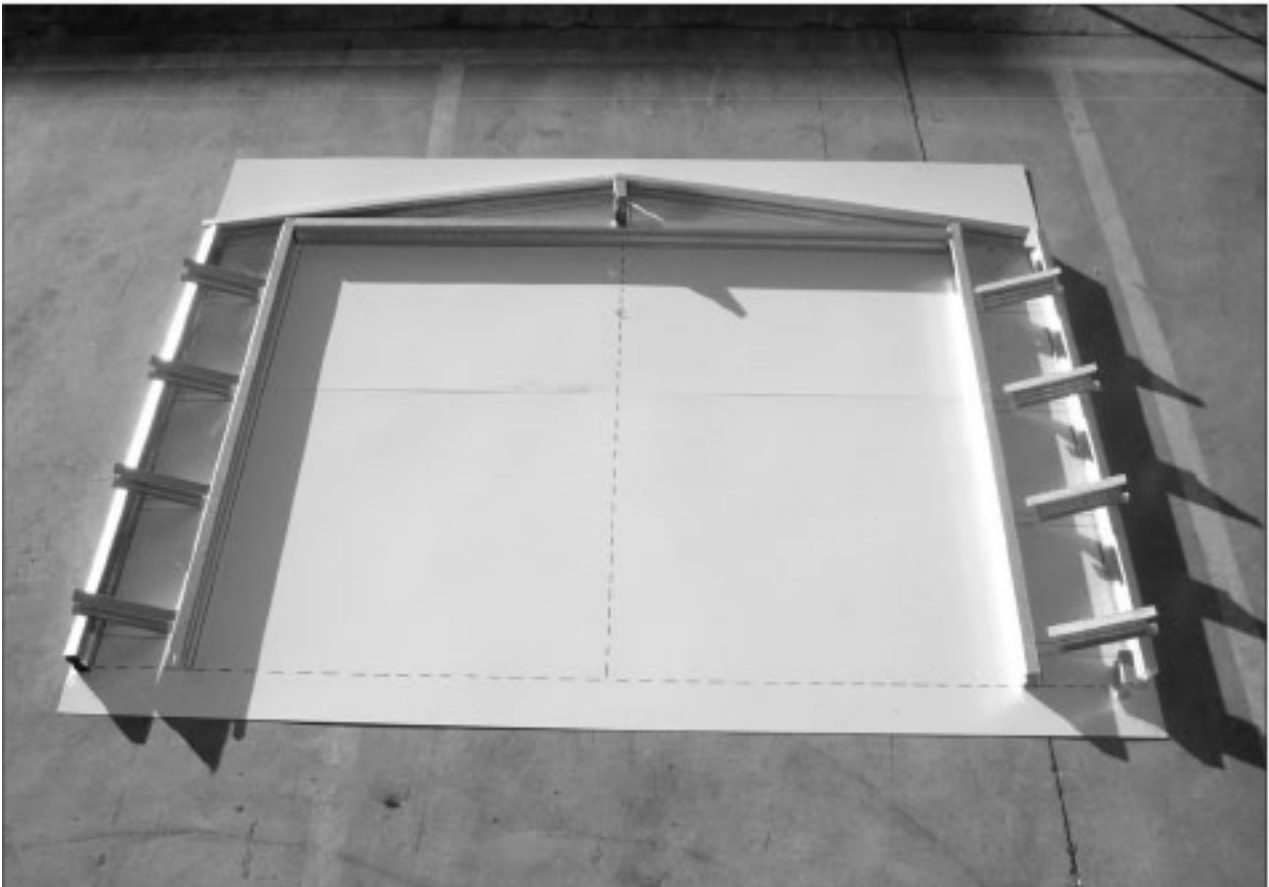

HIGH FRONT FRAME ASSEMBLY SUPPORT PHOTOS

STEP 3.
Join C0100 to C2034

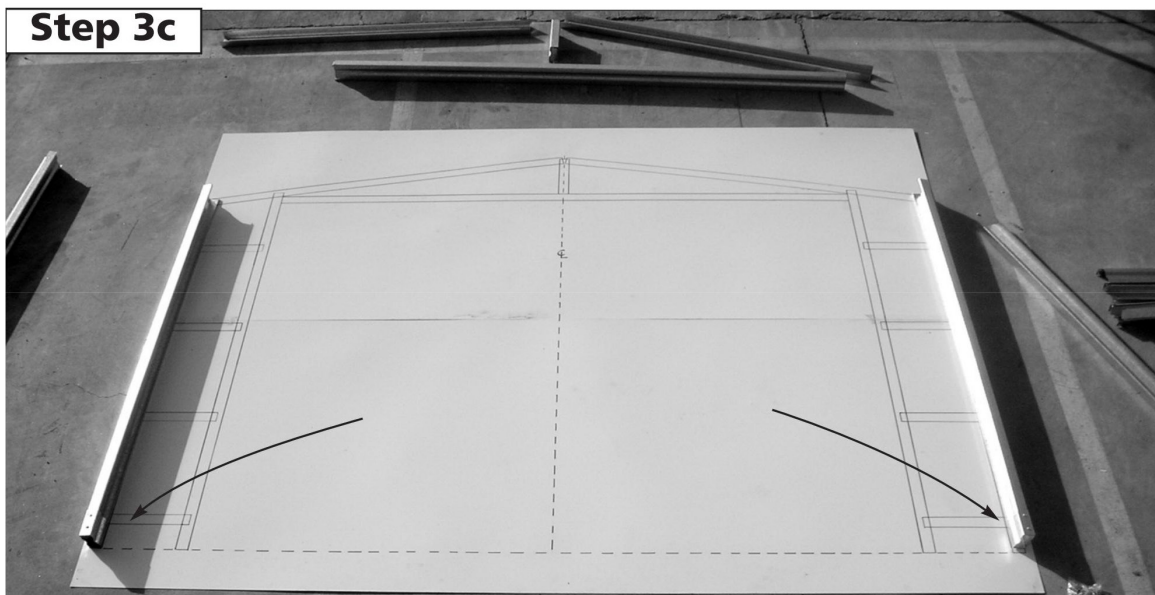
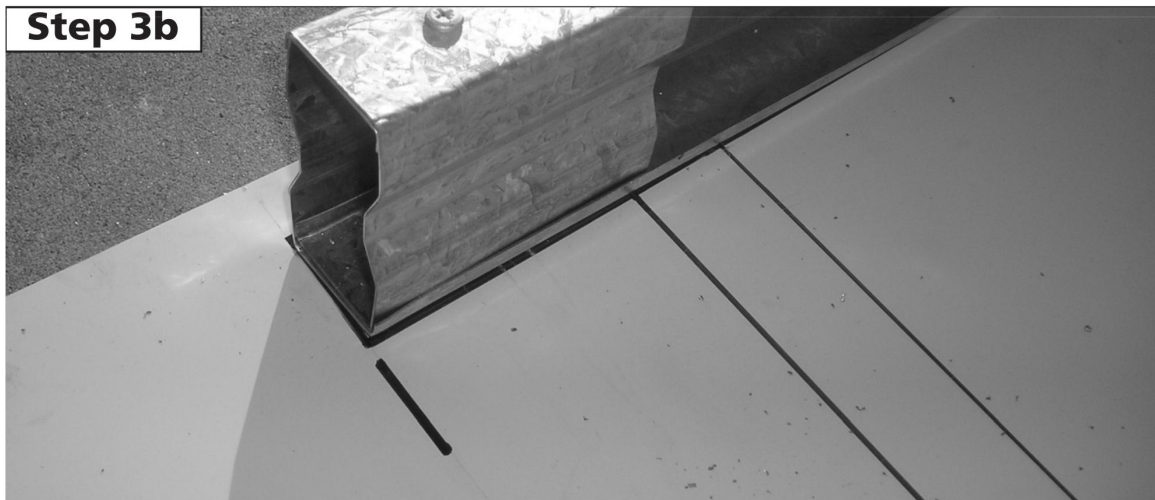
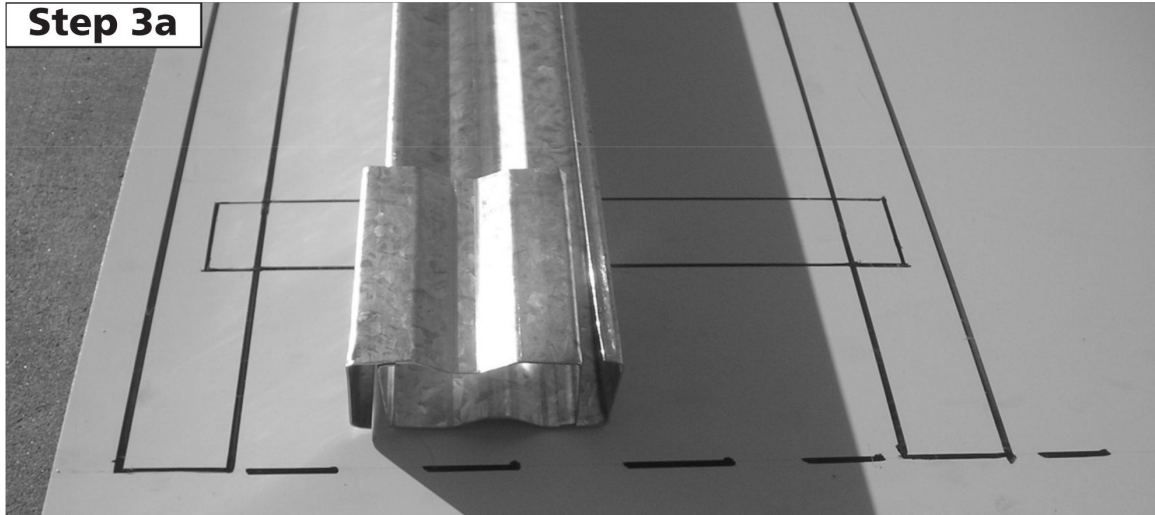

HIGH FRONT FRAME ASSEMBLY SUPPORT PHOTOS

STEP 4.
Join C2034 to M1484

Step 4a



Step 4b

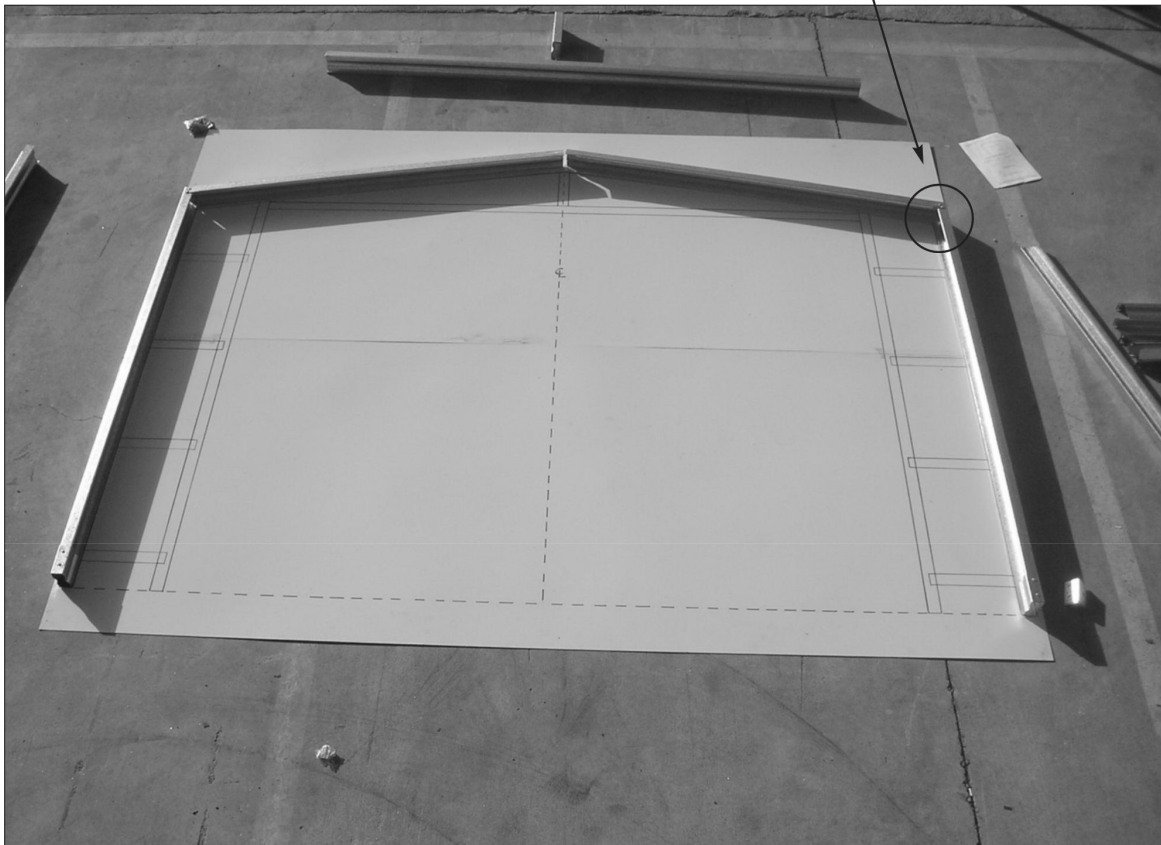

HIGH FRONT FRAME ASSEMBLY SUPPORT PHOTOS

STEP 5.

Join K0285 to C2034 & N2070.

Step 5a



Step 5b

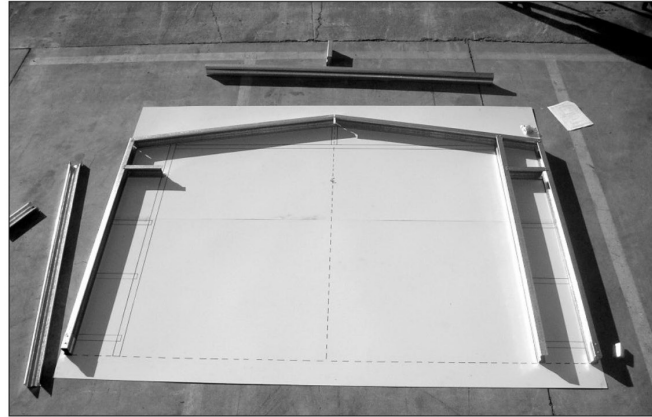

Step 5c



Step 5d

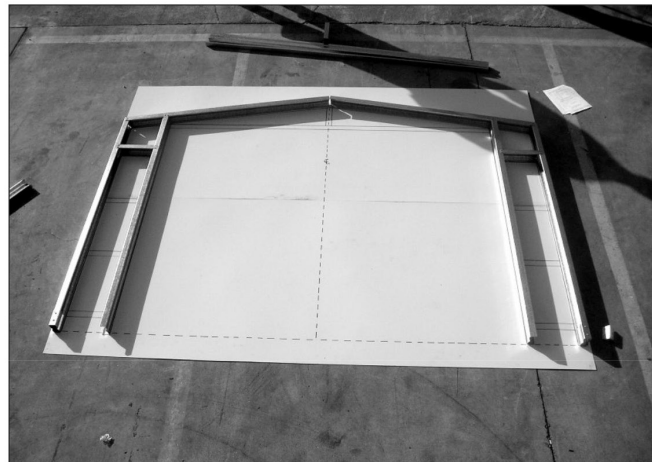

Step 5e

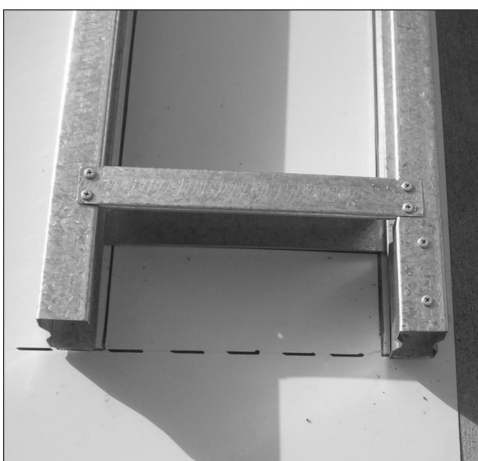

Step 5f

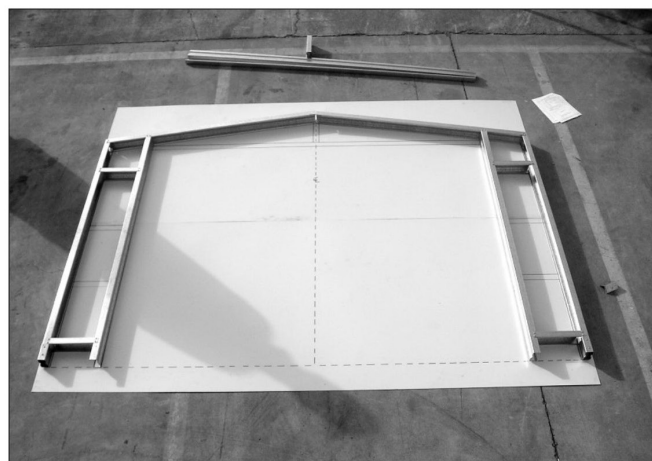

HIGH FRONT FRAME ASSEMBLY SUPPORT PHOTOS

STEP 6.

Fit multipurpose brackets.

Step 6a

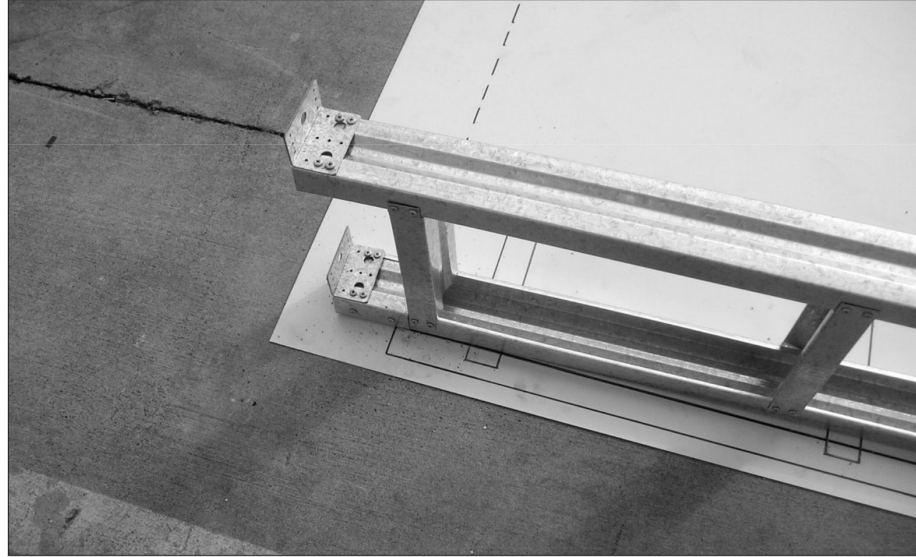

Step 6b

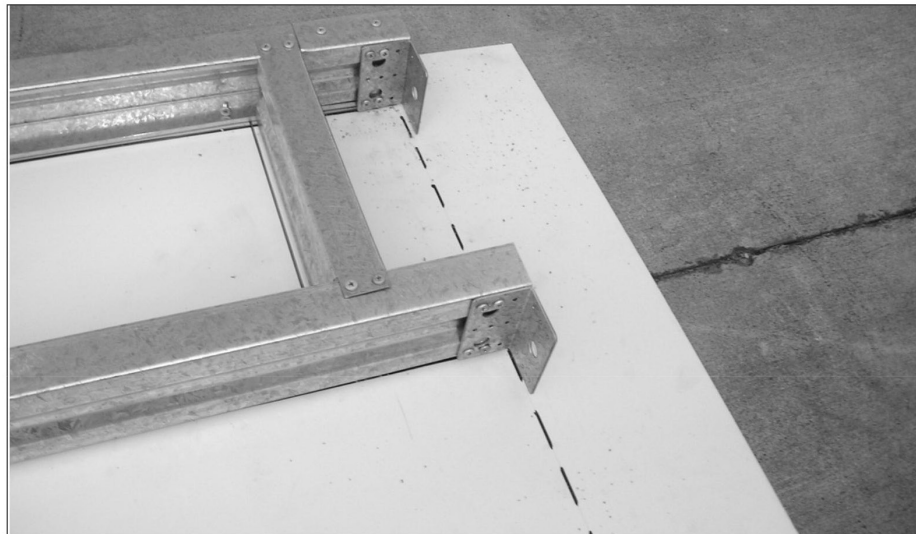

Step 6c

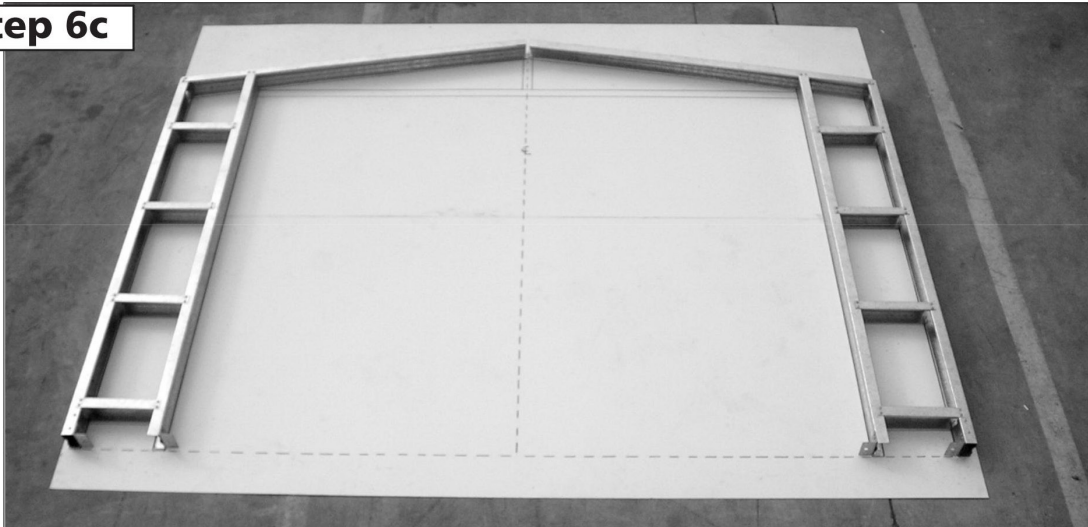

HIGH FRONT FRAME ASSEMBLY SUPPORT PHOTOS

STEP 7.

Assemble the C0240 & C2300 sections.

Step 7a

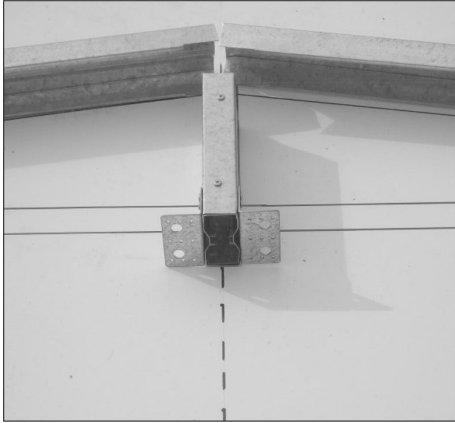

Step 7b

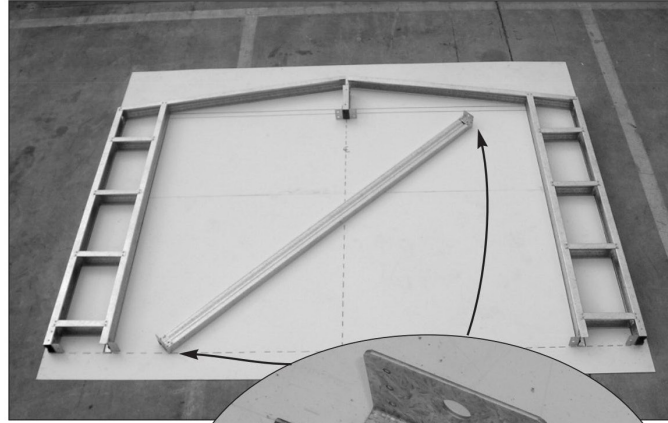

Step 7c

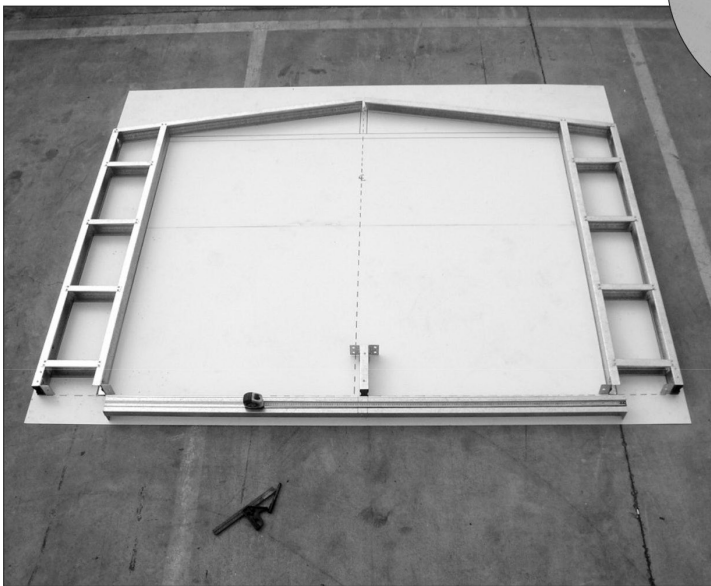

Step 7d

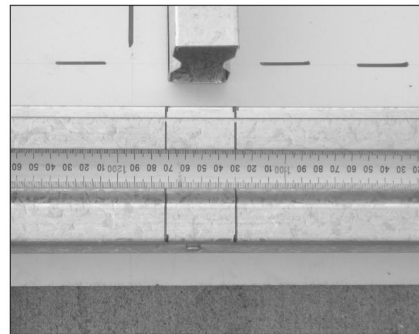

Step 7e

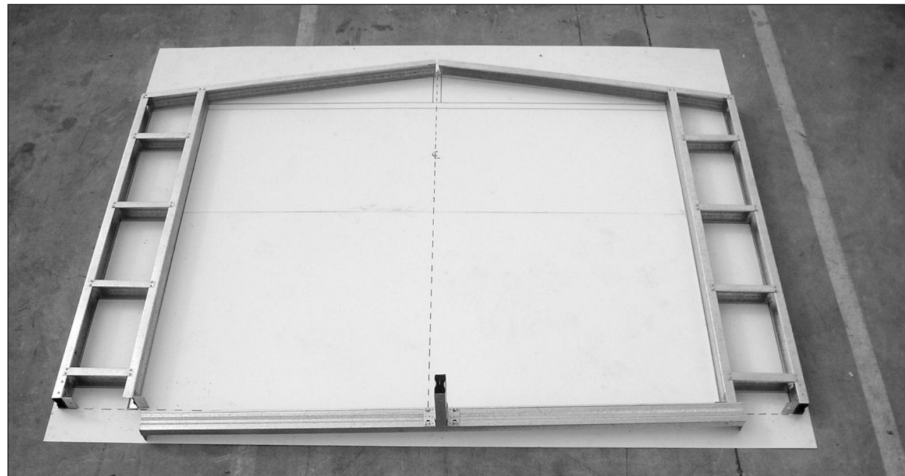

HIGH FRONT FRAME ASSEMBLY SUPPORT PHOTOS

STEP 8.
Join all sections together.

Step 8a

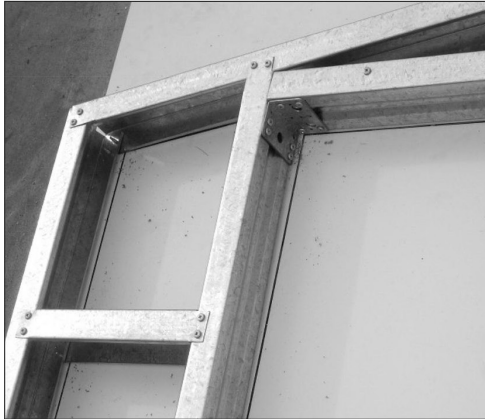

Step 8b

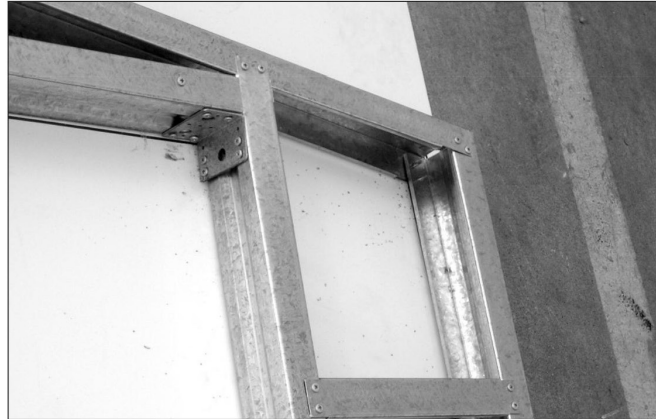

Step 8c



Step 8d



Step 8e



HIGH FRONT FRAME ASSEMBLY SUPPORT PHOTOS

STEP 9.

Turn over frame and repeat steps 4 to 8.

Step 9a

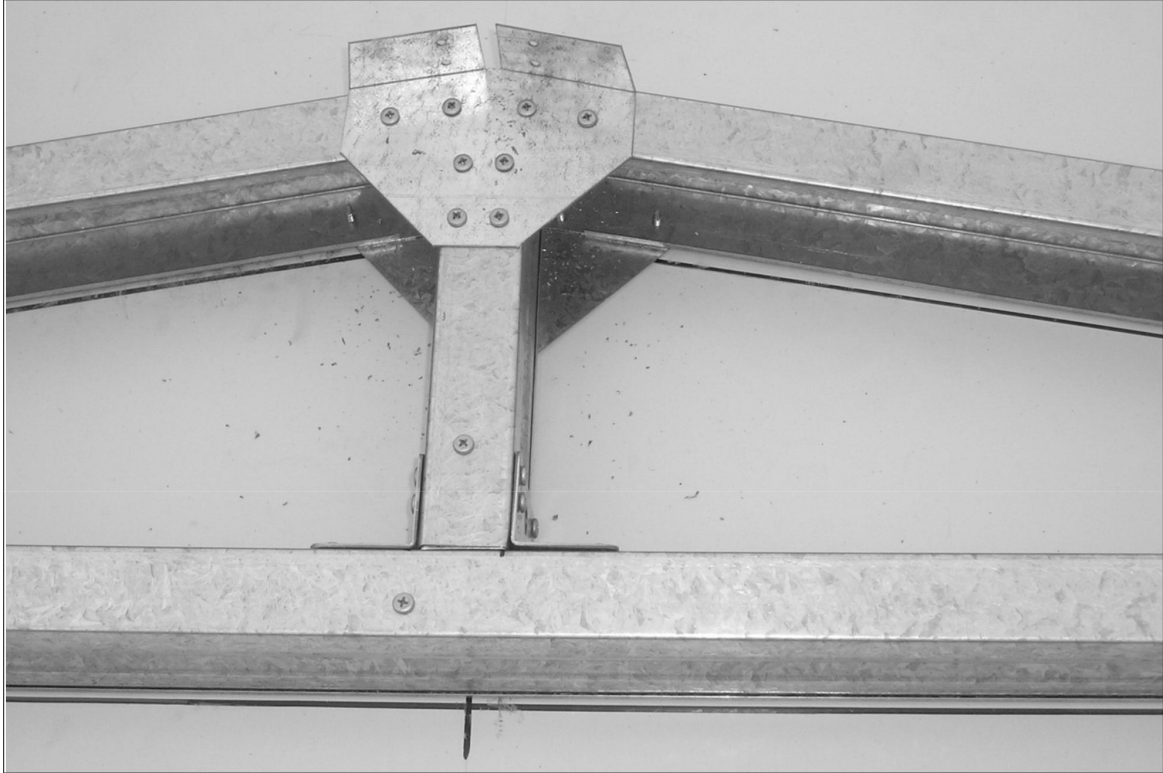

Step 9b



HIGH FRONT FRAME ASSEMBLY SUPPORT PHOTOS

STEP 10.

Fully assembled front frame.

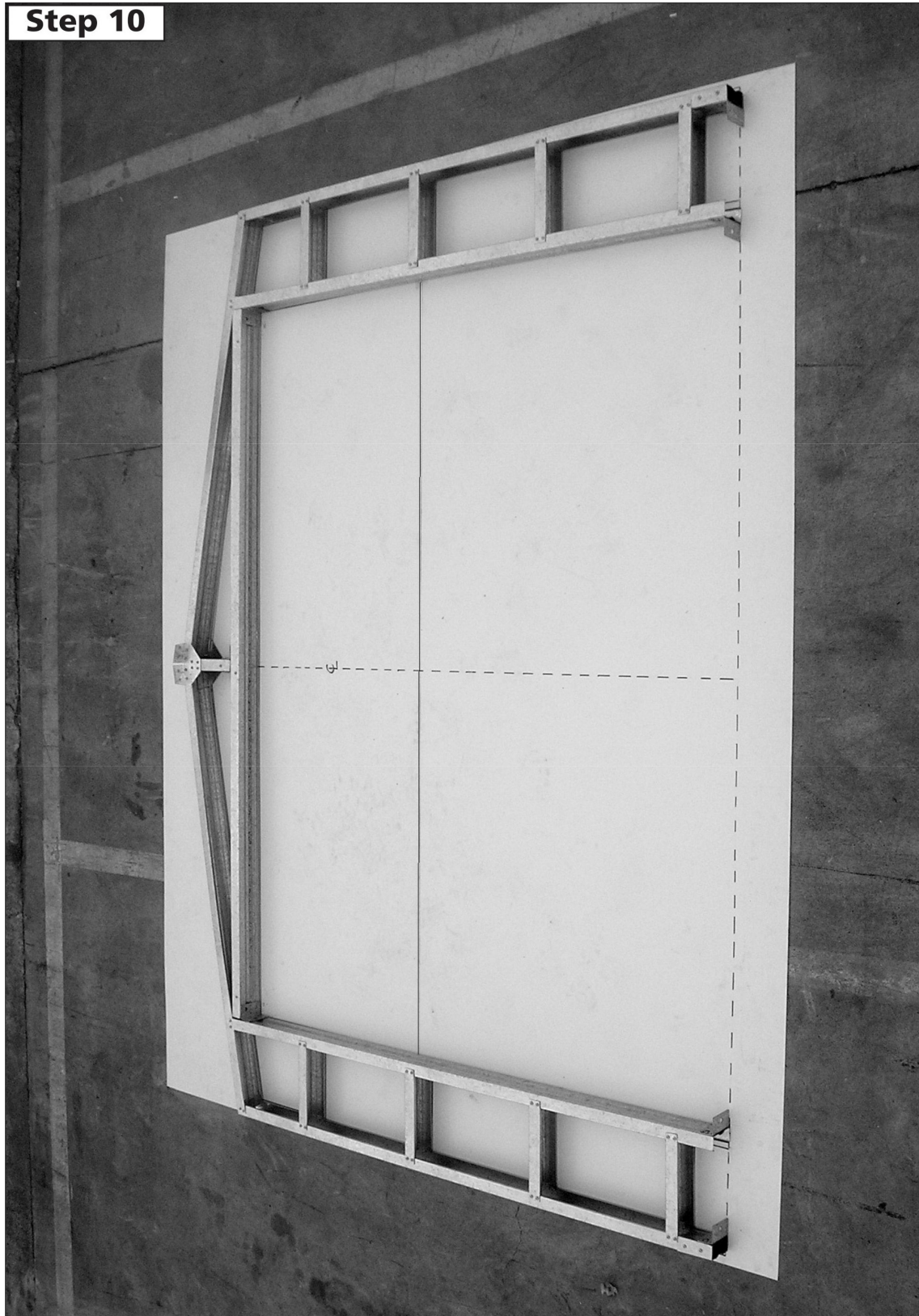

HIGH FRONT FRAME DETAILS

Recommended slab dimensions - 3100mm x 3020mm
External wall dimensions - 3000mm x 2920mm
Internal wall dimensions - 2960mm x 2880mm

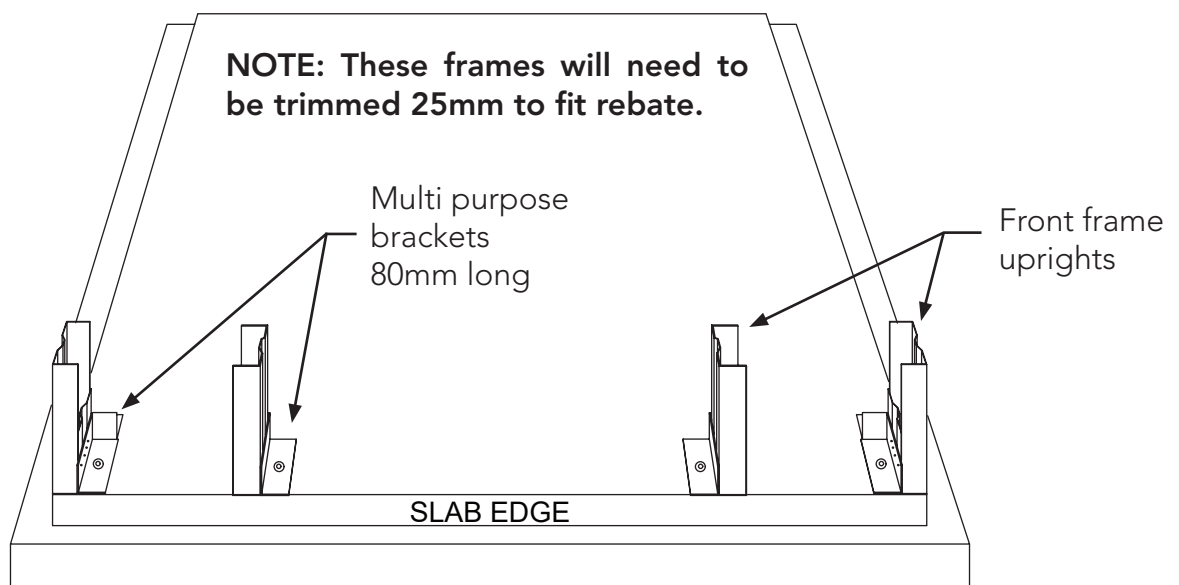
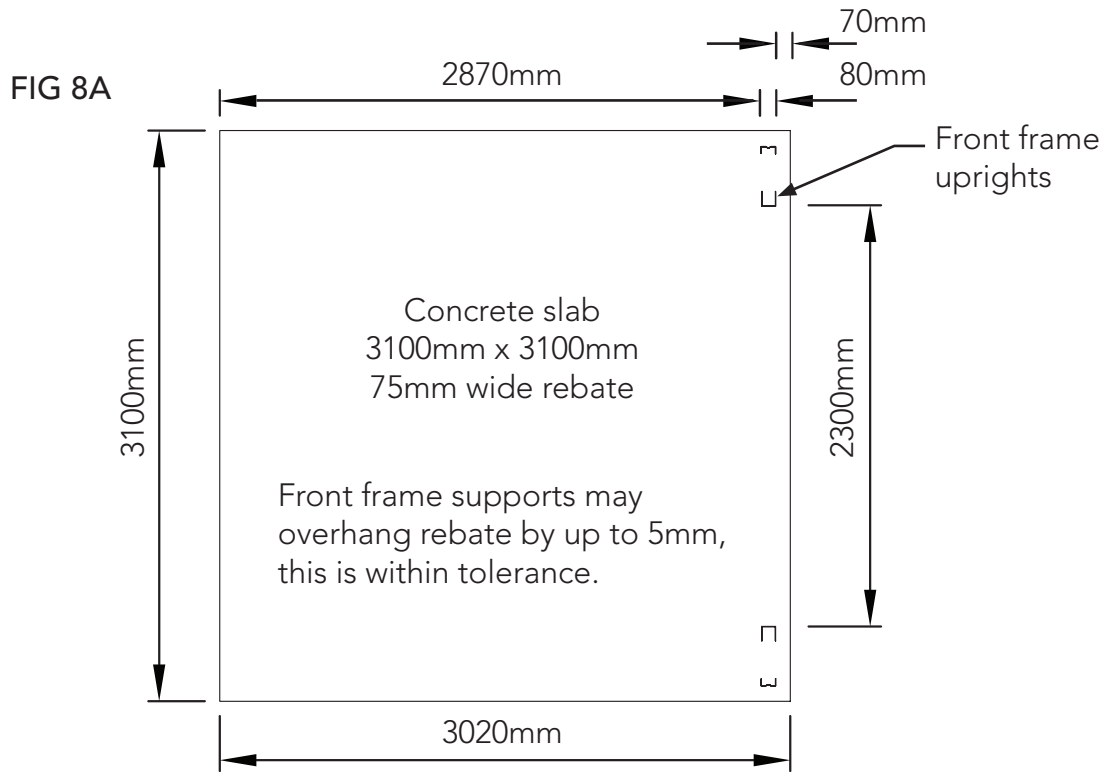

- Secure multipurpose brackets to uprights using self drilling screws
- Move frames into position, mark and drill holes in slab using 10mm masonry drill bit
- Secure frames to slab with M10 dynabolts.

PANEL CONSTRUCTION

NOTE: Take care to ensure that all wall panels are not upside down. The top channels of each panel are pre-punched for attaching roof sheeting. The base channels are not.

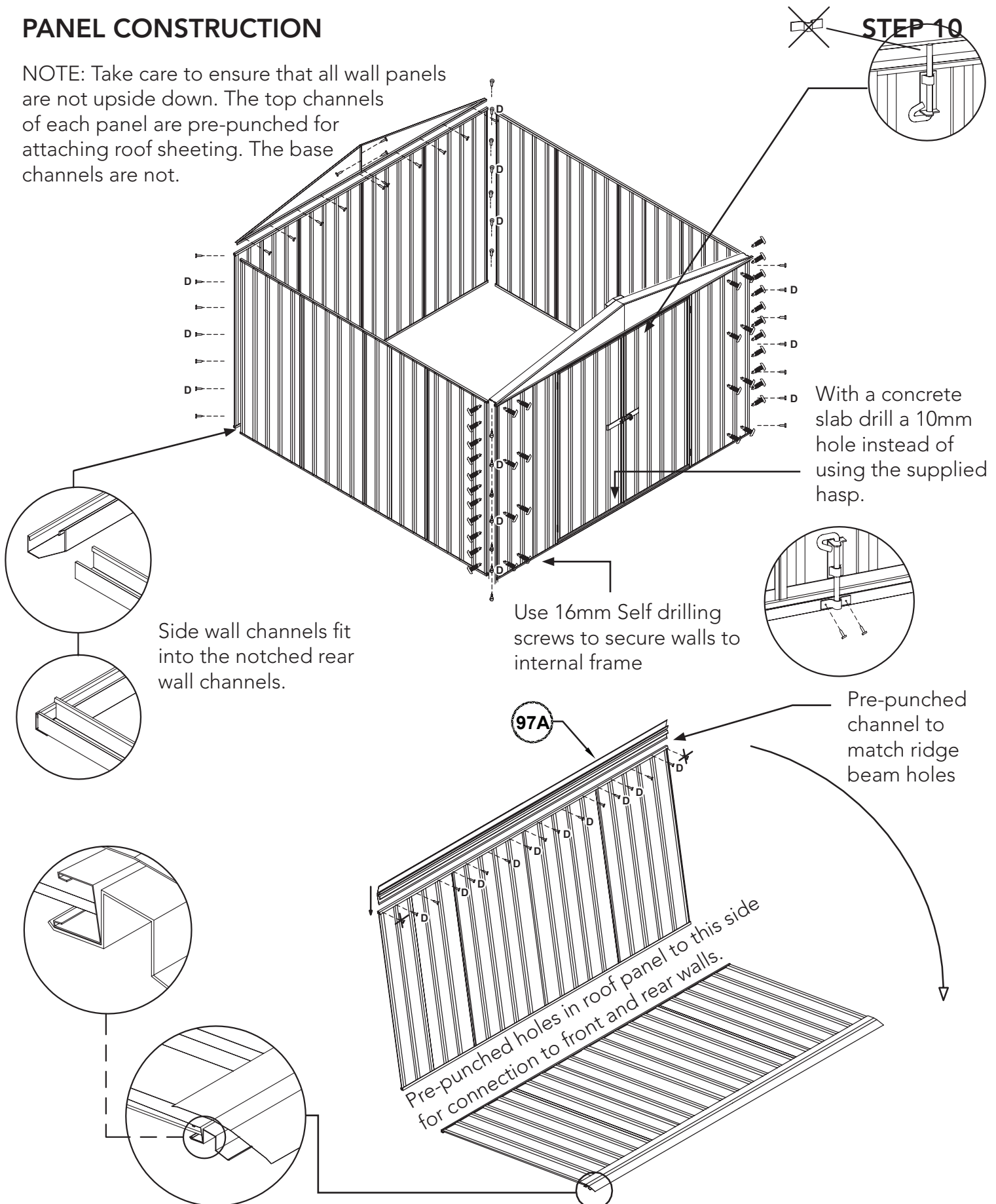

ROOF CONSTRUCTION

STEP 1.

Slide the roof panels into position and secure with only one screw in each corner at this stage.

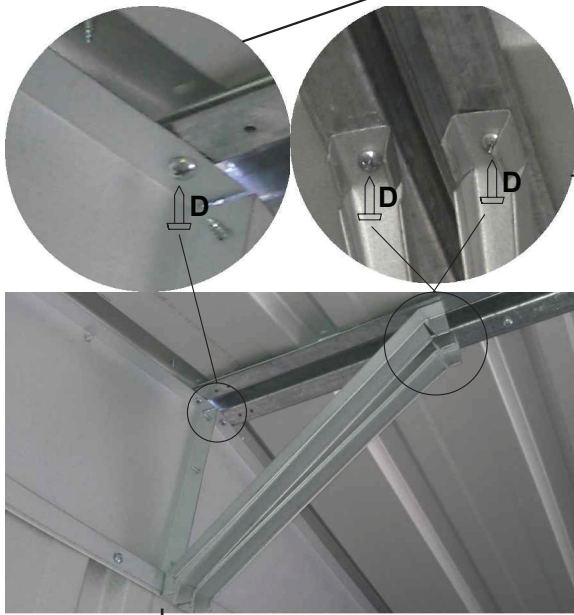

INSIDE VIEW

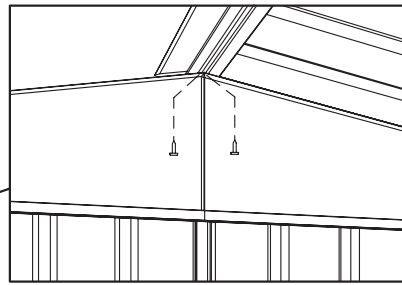

STEP 11

STEP 2.

Secure ridge beam to gable sections with two screws at either end.

INSIDE VIEW

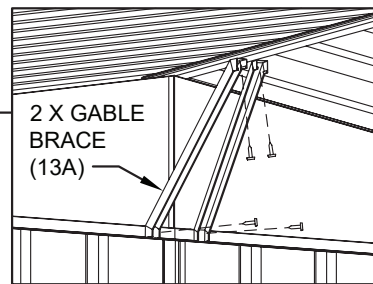

STEP 3.

After the roof panels have been secured, fit two gable braces (13A) from the top wall channel to the underside of the ridge beam at 45 degrees as shown to both gable walls

NOTE: This symbol  denotes that holes to be pre-drilled with a 3mm drill bit before fastening.

- WARNING -

Do not climb on or walk on the roof.

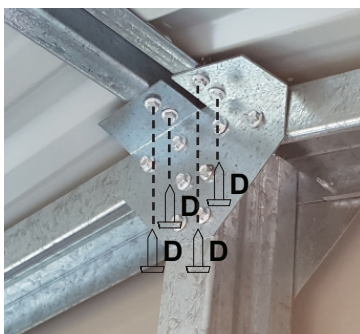
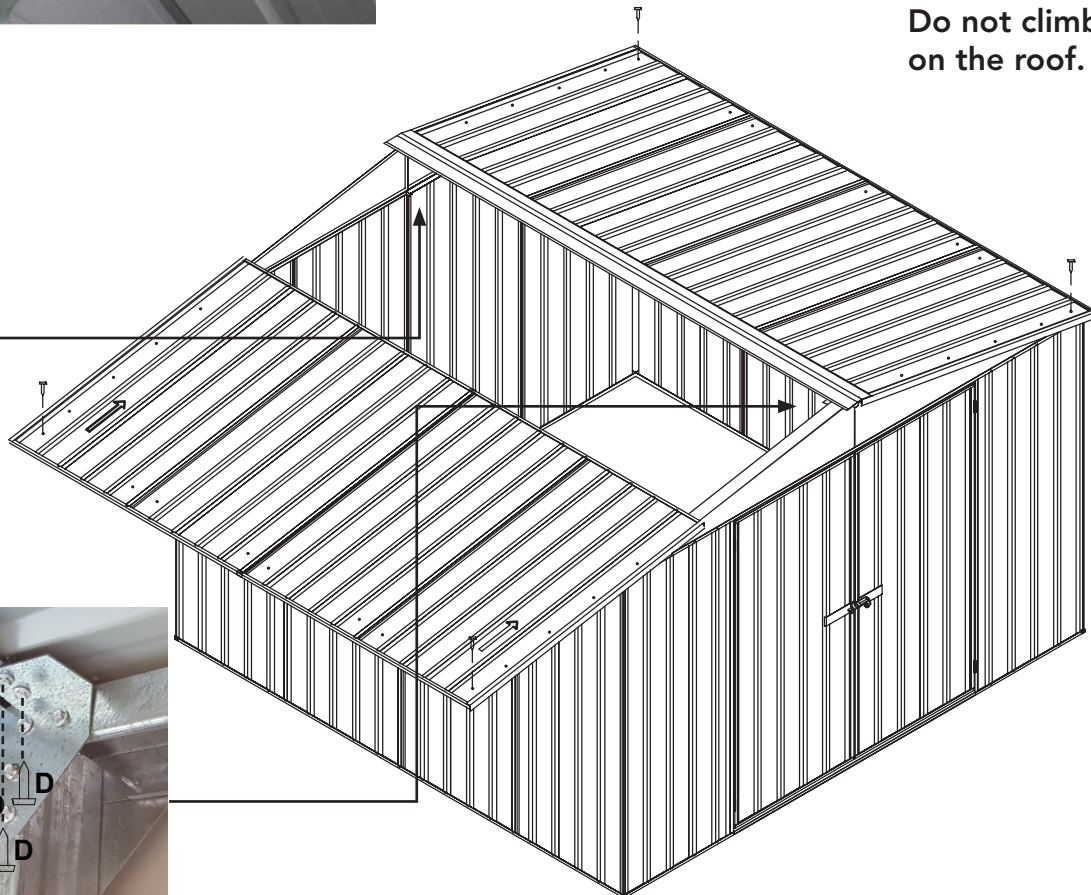

FINAL CONSTRUCTION

STEP 12

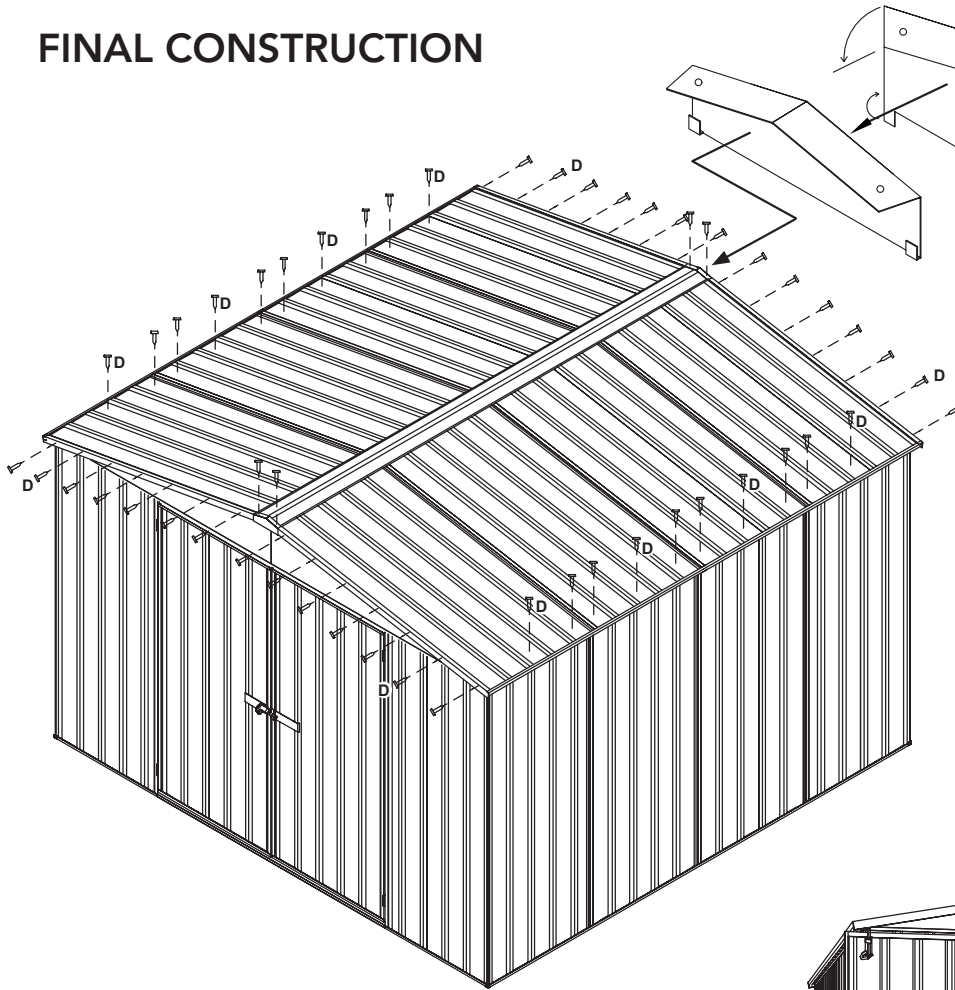

Bend the top and bottom flanges as shown, then hook the bottom flanges under the top channel and screw top to the ridge beam with two screws.

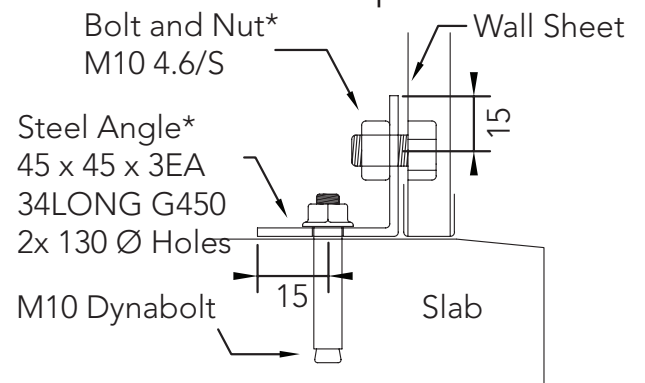
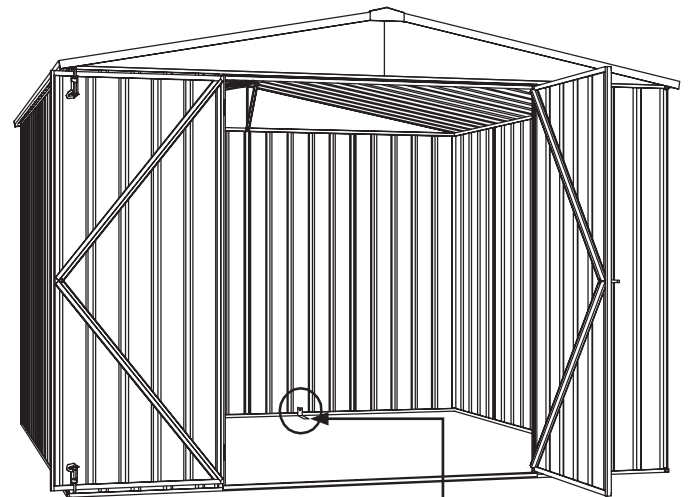
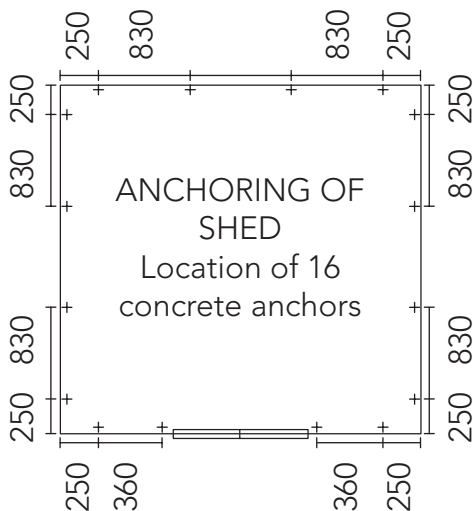

Each anchor consists of one nut, bolt, M10 dynabolt and steel angle.
Drill a 10mm hole into the wall sheet.
Drill a 10mm hole into the concrete.

* Denotes hot dip galvanised finish

Absco Large Gable Roof Shed Notes

General

- 1.G This instruction manual shall be read in conjunction with other consultants drawings, specifications and written instructions provided by Absco and/or their representatives.
- 2.G The drawings provided herein are for installation and structural engineering purposes only. If discrepancies are discovered within the documentation provided, these shall be brought to the attention of Absco and written approvals obtained prior to commencing the affected section of work.
- 3.G If in doubt ask.
- 4.G Until approvals from the local authorities are obtained, commencement of construction from these drawings shall not commence.
- 5.G Unless varied by the project specification, all materials and workmanship shall be undertaken in accordance with the relevant Australian standards and the by-laws and ordinances of the relevant building authorities.
- 6.G All dimensions indicated in these drawings shall be verified on site by the installation contractor. Scaling of drawings shall not be undertaken.
- 7.G Prior to commencing works on site, the contractor shall verify the position of all services in the area to ensure that the construction does not interfere with any of those services.
- 8.G During installation on site the shed structures shall be maintained in a stable condition with no part becoming overstressed or permanently deformed.
- 9.G In circumstances where the shed has been installed in a manner which is inconsistent with the installation manual, structural certification shall be void.
- 10.G The structural components detailed within this installation manual have been designed for the following loads in accordance with AS/NZS1170 based on a Class 10a, Type 2 structure:
- Roof Live Load: 0.25 kPa uniformly distributed or 1.1 kN concentrated as per AS/NZS1170.1

Wind Load: Classification N2, Non-Cyclonic to AS4055 where $V_u = 40$ m/s, $V_s = 26$ m/s

Windward wall $C_{p,e} = 0.7$

Leeward Wall $C_{p,e} = -0.3$ to -0.5 as applicable based on shed geometry

Side Wall $C_{p,e} = -0.2$ to -0.65 as applicable based on shed geometry

Roof $C_{p,e} = -0.3$ to -1.04 depending on wind direction

Absco Large Gable Roof Shed Notes

Steelwork

- 1.S All structural steelwork shall have a corrosion protection system applied consistent with AS/NZS 2312-2002.
- 2.S All structural steelwork detailed within this installation manual shall be minimum Grade 550 for roll formed sections (including roof and wall sheeting and portal frame members) and Grade 250 for angle sections.
- 3.S All multi purpose and anchor brackets for connection onto the supporting reinforced concrete slab (includes 45x45x3EA x 34mm long and 47x47x1.9EA x 80 long) shall be minimum Grade 450.
- 4.S All portal frame knee and apex plates shall be minimum Grade 450
- 5.S All roof, and wall sheeting shall be minimum base metal thickness of 0.3mm
- 6.S All portal frame members shall be minimum base metal thickness of 0.75mm.
- 7.S All snaptite channels and jambs shall be minimum base metal thickness of 0.42mm
- 8.S All top hats shall be minimum base metal thickness of 1.0mm
- 9.S All portal frame knee and apex plates shall be minimum base metal thickness 1.0mm
- 10.S All screw fasteners shall be Phil Pan Head Zinc Plated #8 x 3/4" (STP0820)
- 11.S All bolt fasteners for anchoring shall be M10 minimum grade 4.6/S
- 12.S Installation of screw fasteners shall generally be undertaken in accordance with the relevant provisions of AS1562.

Absco Large Gable Roof Shed Notes

Supporting Slab and Foundations

- 1.F The supporting slab foundation for the garden shed shall be of a minimum size indicated on the installation manual. The top surface of the formed slab shall be level and free of any irregularities which would inhibit the installation of the shed.
- 2.F The structural engineering design for the supporting slab foundation shall be undertaken by a suitably qualified structural engineer. The design shall consider all relevant provisions of AS3600 and AS2870.
- 3.F Between adjacent footings or excavations, the contractor installing the slab foundation shall not exceed a rise of 1 in a run of 2 in line of slope.
- 4.F Unless approved in writing by the slab foundation engineer, the limits of excavations near existing footings shall be in accordance with that indicated below.

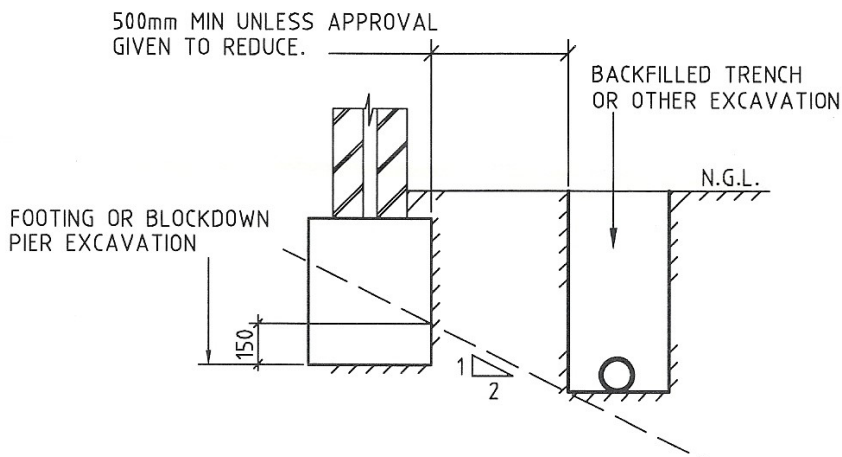

The contractor shall undertake investigatory localised excavations near existing footings to ascertain their depth prior to excavating adjacent to them. It is noted that excavating to a depth below that indicated above shall not be undertaken without the written approval from the engineer.

Absco Sheds Storage Guidelines

- Absco Sheds are designed to be weatherproof for normal weather conditions. In the event of extreme weather conditions such as heavy rain, combined with high wind gusts, the ridge capping, sheeting joints, screw fixings etc., may exhibit minor deformations which may allow some water entry. These areas should be checked regularly to ensure that maximum strength and protection is maintained.
- Other weather conditions such as extreme heat and extreme cold, moist or dry air can influence the effects of concrete floor moisture and/or condensation on the underside of the roof sheets.
- Absco Sheds and storage units are primarily used for storage of garden equipment such as lawnmowers, wheelbarrows, garden tools etc. Storage items that might be adversely affected by any of the above conditions may require additional protection such as being sealed or covered by plastic sheets and/or stacked above the concrete floor on timber slats.
- Waterproof sealants may be used to offer further protection where required around joins and screw fixings, as can rubber door seals and other products which are available from most hardware outlets.
- Placement of waterproof sealants (silicone) between the base of the shed and concrete slab is not recommended, as this process can have a reverse effect, preventing excess water from escaping, resulting with water accumulating and being trapped inside the shed.
- Absco accepts no responsibility for water entry, floor moisture, condensation or the condition of the Contents inside your Absco steel building arising from any of the pre-mentioned weather conditions.

Lifetime Warranty Statement



This warranty against defects is given by:

Absco Industries (ABN: 77 869 708 678)
Address: PO Box 119 Acacia Ridge QLD 4110
Ph: 1800 029 701
Fax: 07 3344 1191
Email: admin@absco.com.au

Date of issue: 19 December 2018

Details of Manufacturer's Warranty

This product comes with a Lifetime structural warranty from the date of purchase. This warranty also applies where there are missing or damaged parts identified in the parts list referred to in the instruction kit within the product packaging.

Please ensure that you keep this warranty form in a safe place along with your proof of purchase. You can register your warranty online <http://absco sheds.com.au/warranty-details/> or complete the form on the back of this document and mail it back to Absco, along with a copy of your proof of purchase.

The benefits of this warranty are in addition to your rights under the Australian Consumer Law (ACL) and in particular, the guarantees implied under the ACL and any other rights and remedies of the consumer under a similar law in relation to the goods and services to which this warranty relates.

Process of claiming warranty:

To make a claim under the warranty within the warranty period, you will need to contact the manufacturer directly by phone or email:

Contact Number: 1800 029 701
Contact Email: admin@absco.com.au

You will be required to produce proof of purchase (this is at discretion of the manufacturer) at the time of the claim.

The manufacturer bears the cost of replacing the products or spare parts or repairing the products and reasonable direct expenses of claiming under this warranty:

Where parts are replaced, the manufacturer will bear the cost of sending the spare part and will endeavour to deliver it to the customer's nearest reseller within 20 working days for the customer to pick up. At such time the customer may be required to return the alleged faulty parts.

Where assessment is required in case of replacing or repairing the product, the manufacturer will appoint an assessor within 10 working days to identify the alleged defect. The manufacturer will bear the repair costs by appointing a local tradesman. The manufacturer may choose to replace the product if the repair or the cost of repair is not feasible. The replacement product will be available for collection from the nearest reseller within 20 working days. The customer will bear the cost of assembly for the replacement product.

IMPORTANT

1. Manufacturer's Disclosure

This warranty against defects shall not apply in the following situations:

- A)Where the product is not assembled in accordance with the instructions provided in the product kit;
- B)Where the product is used to store corrosive materials such as fertilizer, chlorine etc;
- C)The warranty does NOT cover damage caused by storms, wind, rain, snow or poor foundations;
- D)This warranty does not apply to surface deterioration of panels caused by 'Swarf' (Tiny particles of steel debris left from cutting, grinding or drilling operations) that has not been removed after building construction.

2. Notes

This product is weatherproof to a certain level; however driving windy rain may cause the product to leak. Condensation may also occur in some weather conditions such as extreme heat or cold. The product should only be used for storing items such as gardening equipment and should not be used for articles that may be prone to damage if they come into contact with moisture.

3. Major Defects

If the manufacturer is satisfied that the defect is a major defect, the purchase price may be refunded in lieu of providing a replacement product or repairing the product.

This warranty is provided in addition to other rights and remedies you have under law: Our goods come with guarantees which cannot be excluded under the Australian Consumer Law. You are entitled to replacement or refund for a major failure and to compensation for other reasonably foreseeable loss or damage. You are also entitled to have the goods repaired or replaced if the goods fail to be of acceptable quality and the failure does not amount to a major failure.

If you do not wish to register your warranty online, complete the below form and email, fax or post this form back to Absco, along with a copy of your proof of purchase.

NAME: _____

STREET ADDRESS: _____

POSTAL / ZIP CODE: _____

STATE / CITY / PROVINCE / REGION: _____

COUNTRY: _____

SHED TYPE/CODE: _____

ORDER NO: _____

DATE OF PURCHASE: _____

EMAIL ADDRESS: _____

DATE REGISTERED: _____

