

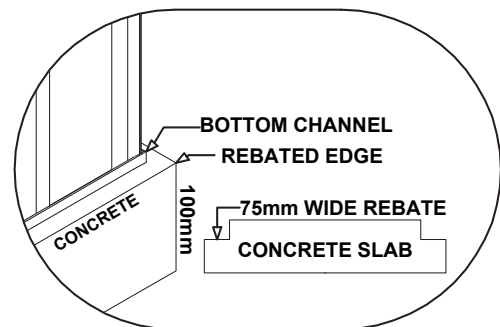

When laying concrete slab, ensure there is a rebated edge 25mm deep around the perimeter. This will help water egress from the base of the shed.





**DOWNLOAD  
OUR APP FOR  
ASSEMBLY  
VIDEOS**



**PLEASE LEAVE A REVIEW**

Tell us about your experience!  
Visit [www.absco.sheds.com.au/review](http://www.absco.sheds.com.au/review)

## GENERAL INSTRUCTIONS

- Before commencing any assembly, read through these instructions in detail to gain a thorough understanding of assembly methods and associated details.
- Unpack the carton and carefully identify and check off all the parts against the parts described and illustrated on "COMPONENTS PACKING LIST" pages.

## SITE PREPARATION

- The site for the shed must be level. An uneven surface may result in misalignment of parts.
- The shed shall be erected on top of a reinforced concrete slab and anchored down appropriately illustrated on "FINAL CONSTRUCTION" page.

## TOOLS REQUIRED



## SAFETY NOTES











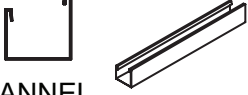

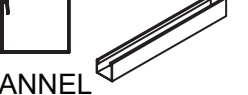

- Some parts may have sharp edges. It is advisable to wear gloves when handling these items and safety glasses if drilling holes. Sensible shoes are highly recommended.
- Do not erect your shed in windy conditions.
- Ensure that the shed is securely anchored to a solid foundation immediately after construction is completed.
- It is highly recommended to erect the shed with two or more people.
- Do not sit, stand or walk on the roof of your shed.

## RECOMMENDED

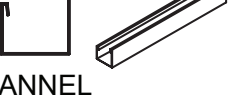

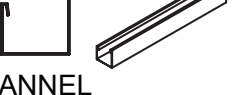
**COMPONENT PACKING LIST**

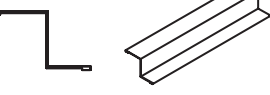









Check off all components.

QTY	COMPONENT DESCRIPTION	PART No.	CHECK	QTY	COMPONENT DESCRIPTION	PART No.	CHECK
2	 STEEL SHEET 1915 X 773mm	43B		2	 CHANNEL L = 786mm	61B	
2	 STEEL SHEET 1915 X 773mm	43C		2	 CHANNEL L = 773mm	81J	
1	 STEEL SHEET 1915mm X 773mm	X4L		1	 CHANNEL L = 1568mm	79A	
1	 STEEL SHEET 1915mm X 773mm	X4R		2	 CHANNEL WITH HINGES L = 1725mm	58A	
4	 STEEL SHEET 865mm X 773mm	43D		1	 CHANNEL L = 1725mm	58B	
2	 STEEL SHEET 1785mm X <u>711mm</u>	34A		4	 CHANNEL L = 773mm	58C	
1	 STEEL SHEET 1725mm X 773mm	A		2	 JAMB L= 1785mm	89A	
1	 STEEL SHEET 1725mm X 773mm	B					

Nominal sheet widths are shown. +/- 2mm is within tolerance.









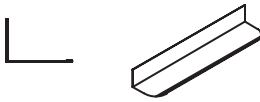

## COMPONENT PACKING LIST

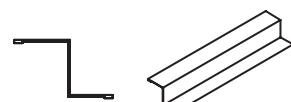
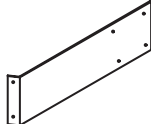
Check off all components.

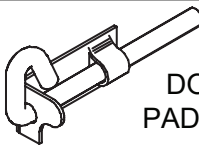
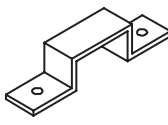
QTY	COMPONENT DESCRIPTION	PART No.	CHECK	QTY	COMPONENT DESCRIPTION	PART No.	CHECK
1	 CHANNEL L = 1496.5mm (58.9")	55AL		1	 CHANNEL L = 1496.5mm (58.9")	55AR	
1	 CHANNEL L = 1496.5mm (58.9")	55CL		1	 CHANNEL L = 1496.5mm (58.9")	55CR	
1	 CHANNEL L = 1496.5mm (58.9")	55BL		1	 CHANNEL L = 1496.5mm (58.9")	55BR	
1	 CHANNEL L = 1496.5mm (58.9")	81BL		1	 CHANNEL L = 1496.5mm (58.9")	81BR	
2	 CHANNEL L = 1496.5mm (58.9")	81AL		2	 CHANNEL L = 1496.5mm (58.9")	81AR	

## COMPONENT PACKING LIST

Check off all components.

QTY	COMPONENT DESCRIPTION	PART No.	CHECK	QTY	COMPONENT DESCRIPTION	PART No.	CHECK
2	 LIP TRIM L= 865mm	88B		1	 JAMB L= 1568mm	90A	
1	 JAMB L= 1725mm	89C		4	 JAMB L= 1120mm	91A	
<b>INSTRUCTIONS &amp; FITTINGS PACKET</b>							
1	ASSEMBLY INSTRUCTIONS			2	 DOOR STRAP L: 165mm	12A	
1	PSTKSG L DOUBLE DOOR FITTINGS PACK			6	 CHANNEL JOINER L= 200mm (7.9")	CSJ	
<b>PSTKDBL - DOUBLE DOOR FITTINGS PACK</b>							
3	 DOOR PADBOLT	FAST006		1	 DOOR PADBOLT HASP	FAST007	
1	3mm DRILL BIT 	DRILL		1	PHILLIPS DRIVER BIT 	FAST038	
1	 SELF TAPPING SCREWS PACKET CONTAINING 220			1	PACK 12P SCREW PACK 12		
<b>PACK 12P - SCREW PACK 12</b>							
12	 3/16 COUNTERSUNK SCREWS & NUTS			12	 3.2 x 8mm BLIND POP RIVETS		

PSTKSG L -

## SNAPTITE ASSEMBLY GUIDE

The Snaptite Assembly System locks end channels to all roof and wall sheets without the need for tools and fasteners.

To assemble each panel, the perimeter channels are secured to the top and bottom of each panel. Gently tap the channel over the SNAPTITE lugs on the sheet, working along the sheet.

Each perimeter channel must finish flush with the edges of the sheets. Simply tap the channel along the sheets until each end is neatly flush. If you need to remove channels from the panels, slide it off from the side.

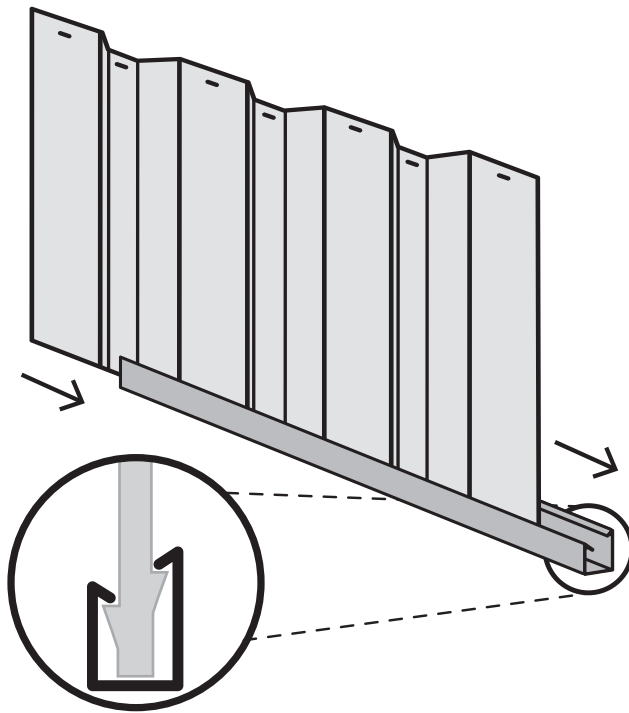

**SNAPTITE**  
World's Easiest Assembly System  
*UNIQUE PATENTED SYSTEM*

Channel locks the shed panel into position without the need for screws!

### FASTENING SYMBOLS

**SNAPTITE**

Secure channel to sheeting by SNAPTITE fastening method.



Join components together with one screw at this location only, as some channels have extra holes that are not required for this model of shed.

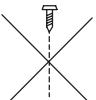

Do not join components together at this location yet, as the screws may obstruct further assembly of the other components.



Join components together by pre-drilling the holes first. Use one component as template to mark where the holes are and drill with a 3mm drill bit.



3mm pop rivet



4mm nut and bolt set.

## Guide on Joining Spliced Channels

The text marked on all parts must be shown on the same side as each other



**Step 1.**  
Position the channels and the CSJ joiner so the centre of the CSJ is in line with the end of each channel to be joined together.

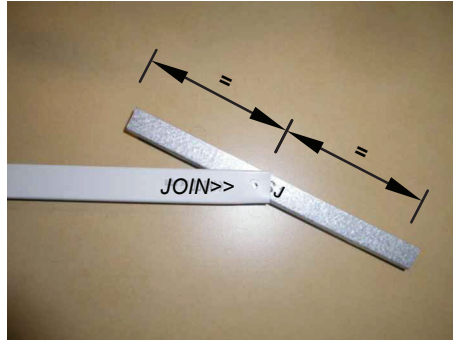

**Step 2.**  
Join the first channel to the CSJ by inserting the centre of the CSJ, on an angle, to the end of the channel where the JOIN>> text is marked.

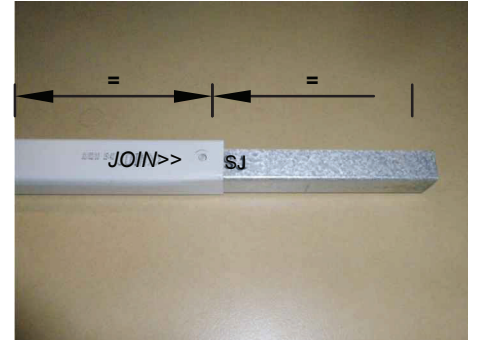

Push down one side of the CSJ until you hear a 'click'.

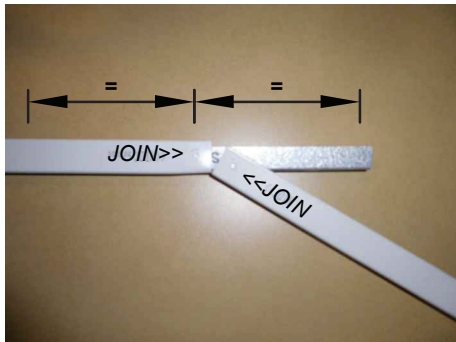

**Step 3.**  
Join the second channel to the CSJ by positioning the <<JOIN of the channel at the centre of the CSJ, on an angle. Push the CSJ into the channel until you hear a 'click'.

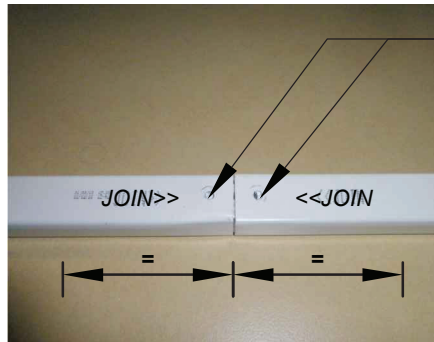

**Finished Channel.**  
The joined channels should now look like the picture with the CSJ positioned equally inside of the joined channels.

Drill out holes with 3mm drill bit in CSJ to match the holes in channel. Drilling of screws on the joined channels is being done after sheets are locked on the spliced channels.

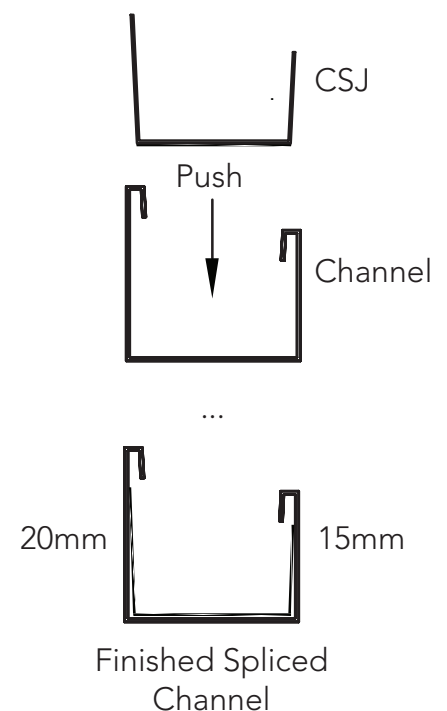

## PRE-ASSEMBLY OF SPLICED CHANNELS

Join together 12 x channel sections using 6 x channel joiners (Part CSJ)

NOTE: Some channels may have holes in them - You will need to redrill holes where CSJ joining channel covers them.

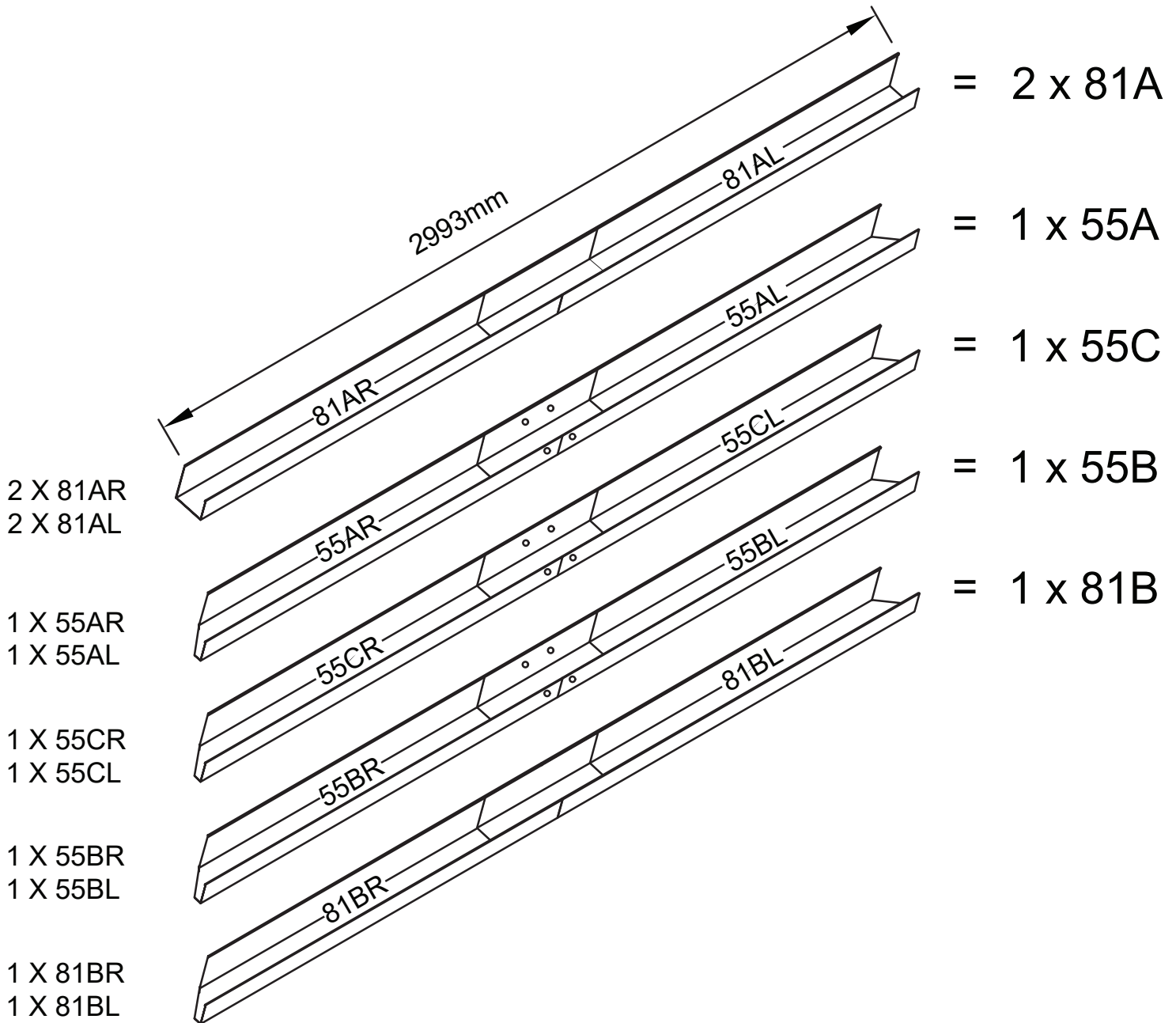



**ROOF COMPONENT OVERVIEW**

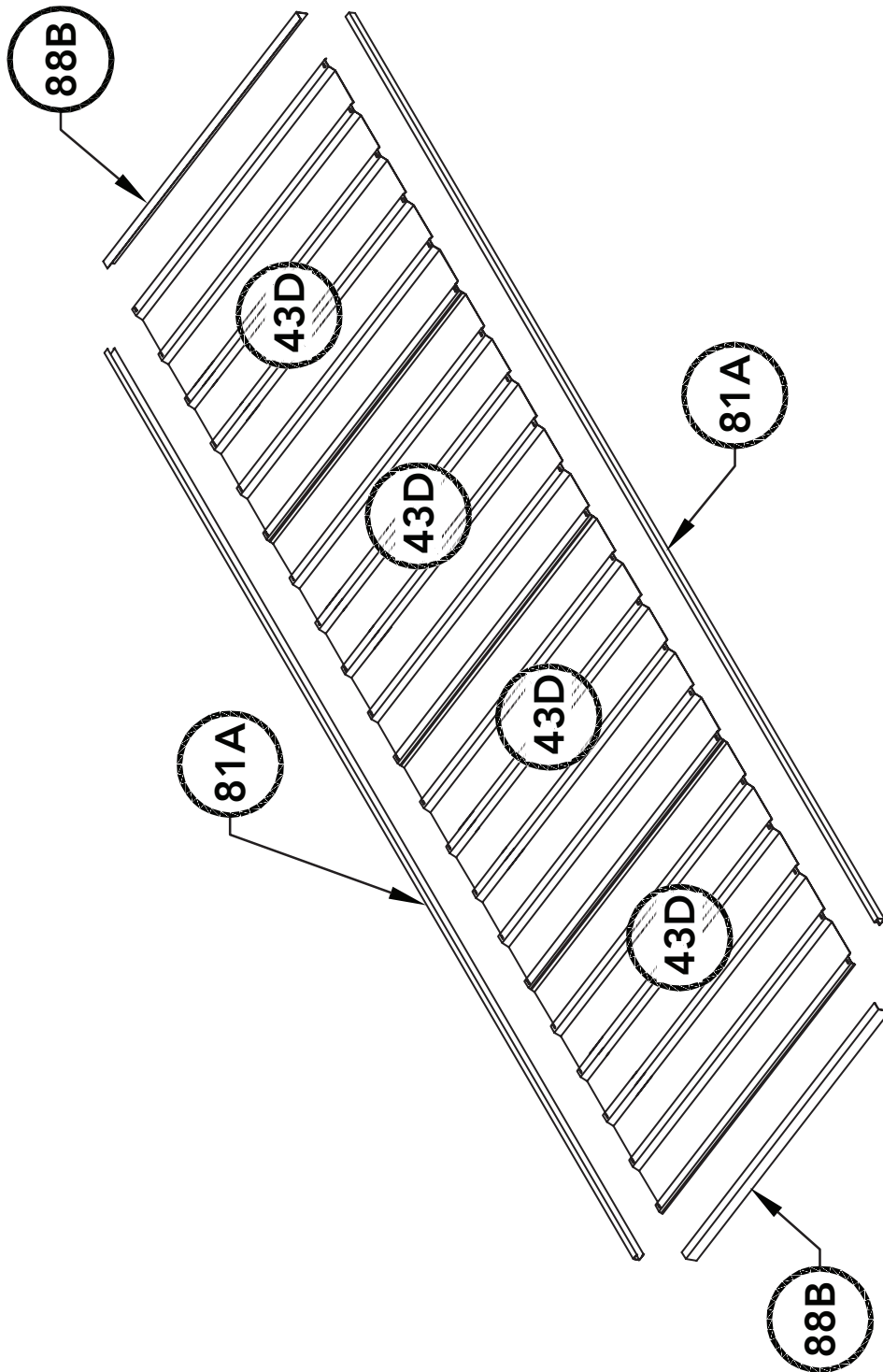

**ROOF COMPONENT OVERVIEW**

**WALL COMPONENT OVERVIEW**

WALL COMPONENT OVERVIEW

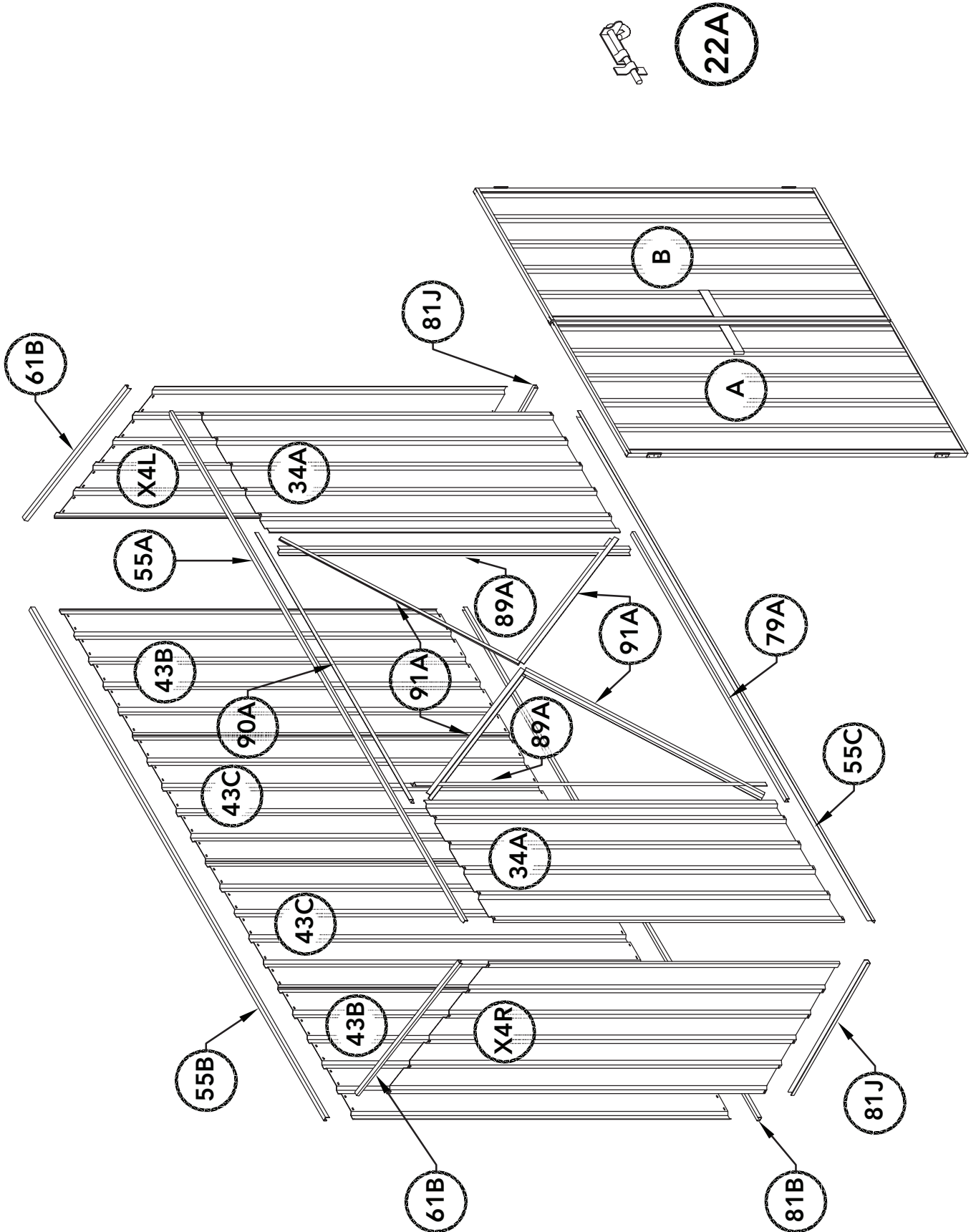

**REAR PANEL ASSEMBLY**

1x required

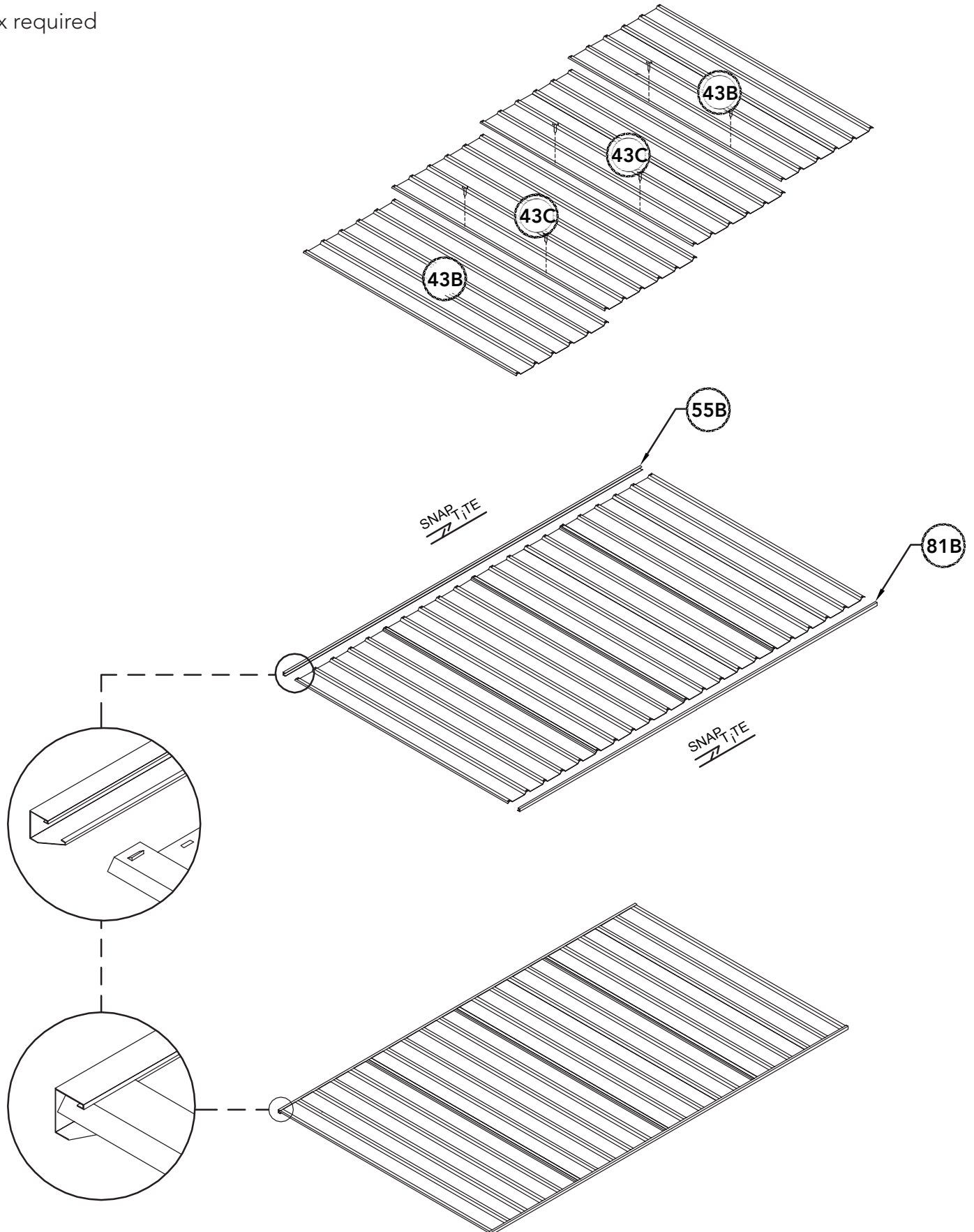

## SIDE PANEL ASSEMBLY

2x required.

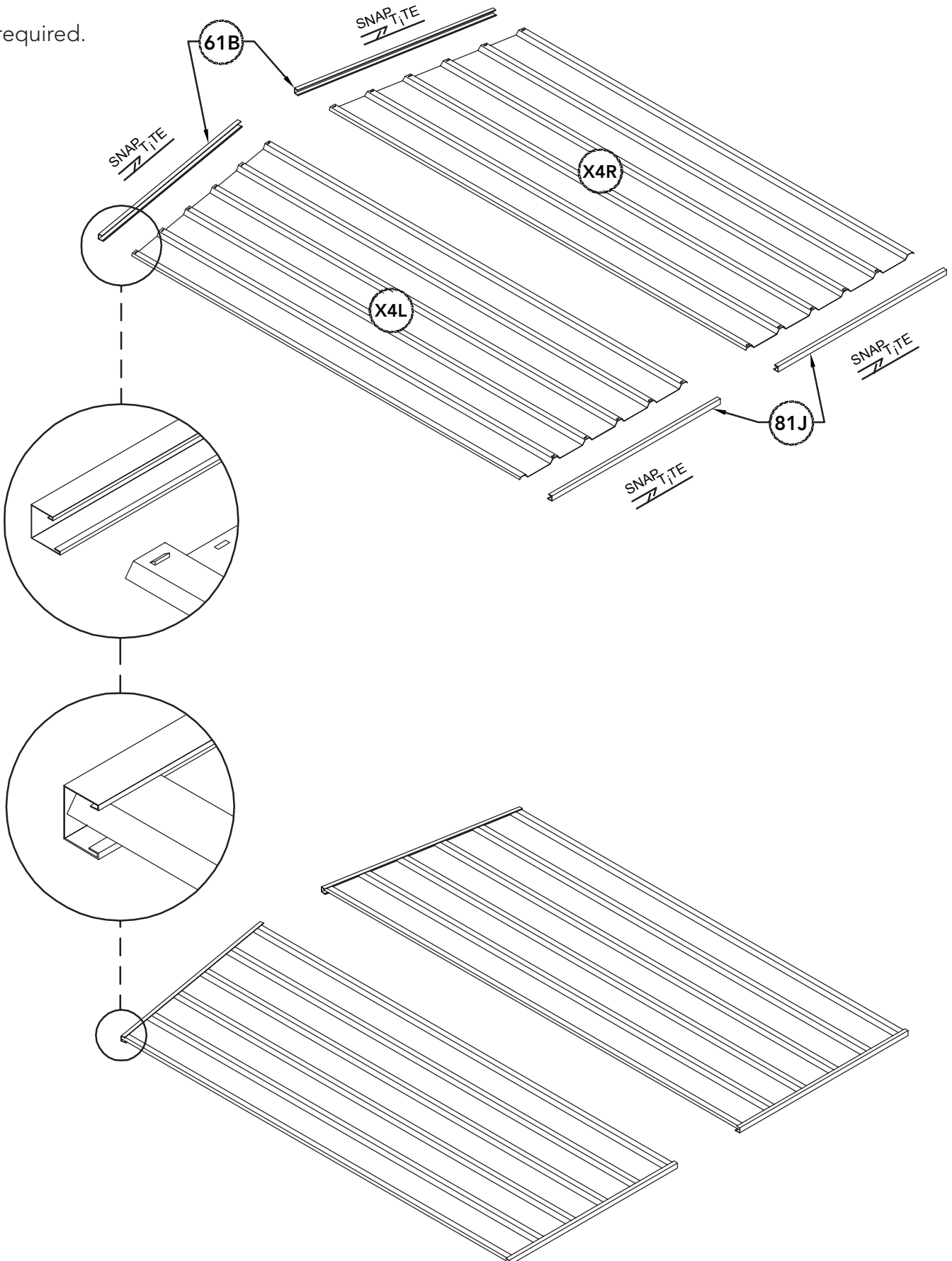

**ROOF PANEL ASSEMBLY**

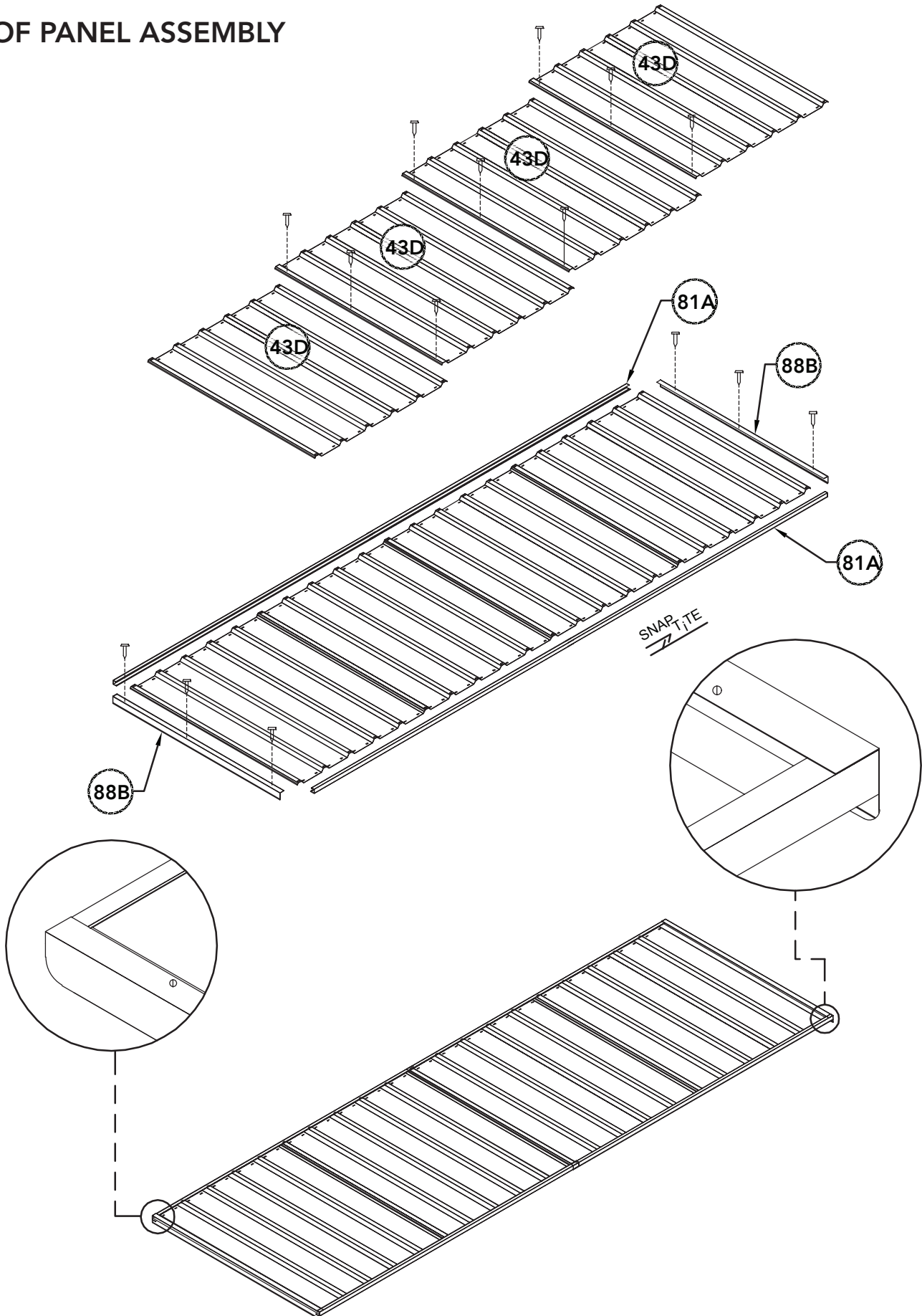



**DOUBLE DOOR ASSEMBLY**

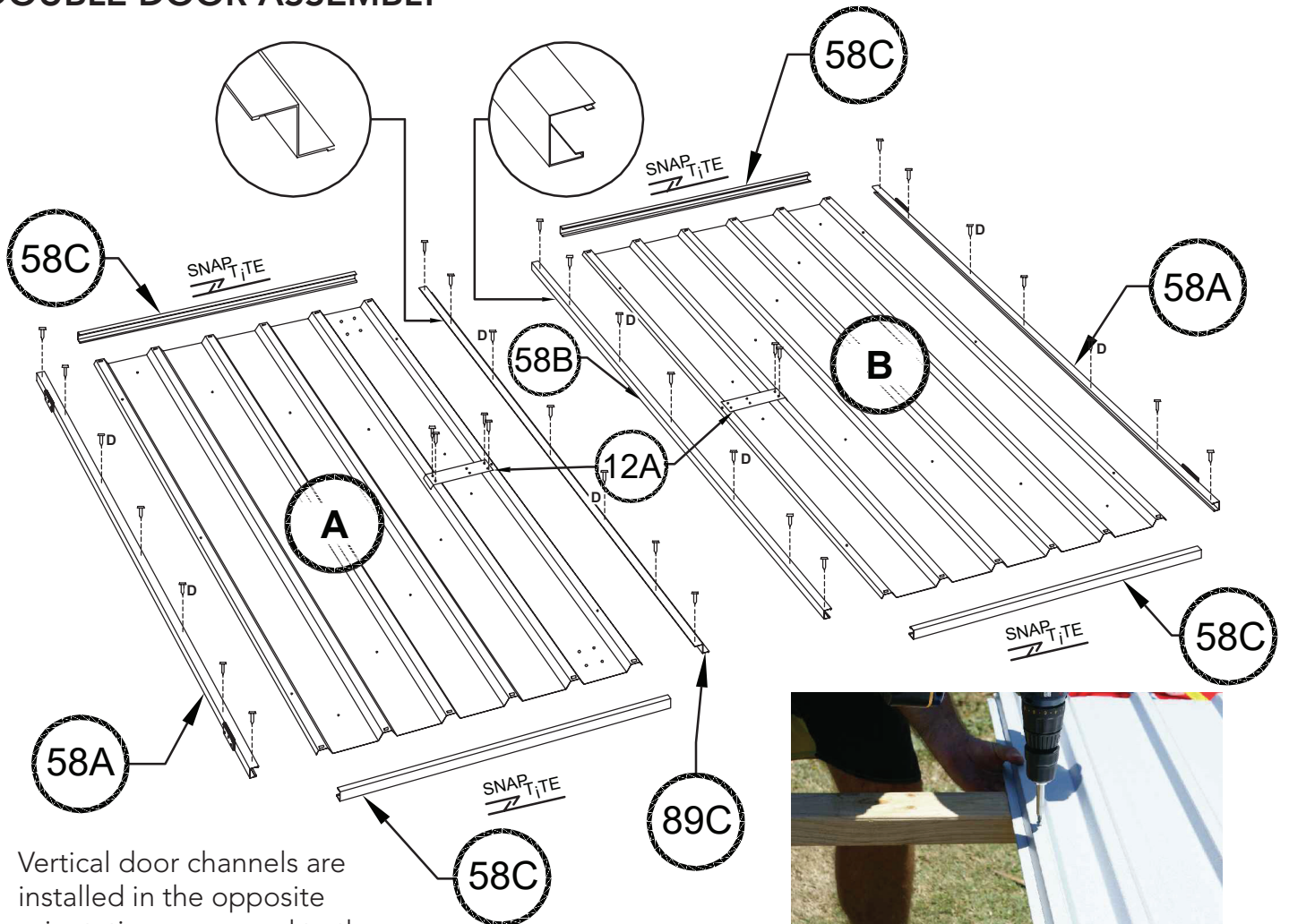

Long flange of channel

Short flange of channel

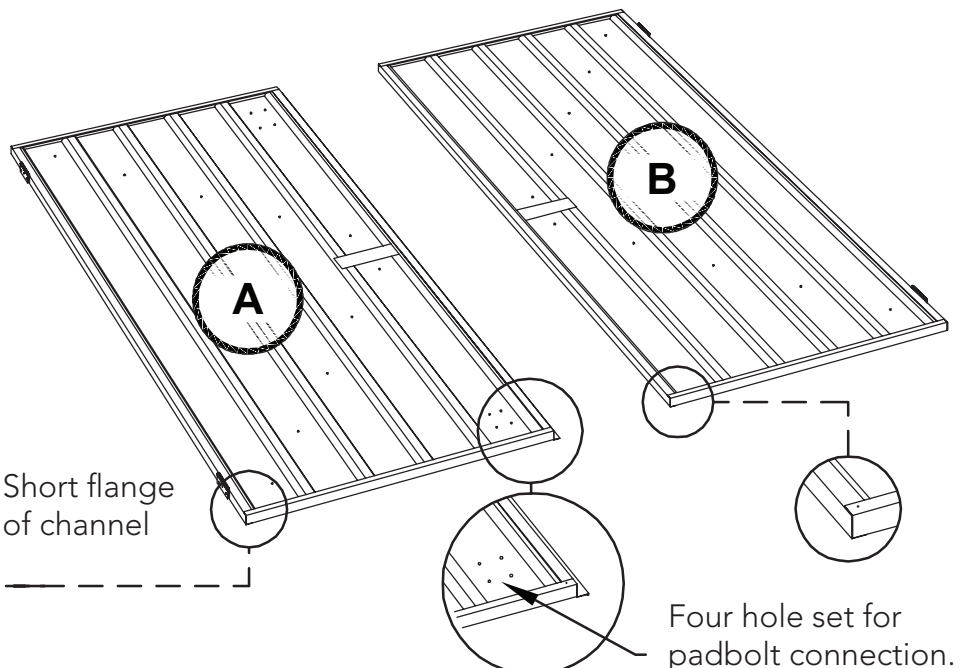
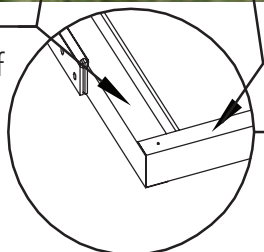

## FRONT PANEL ASSEMBLY

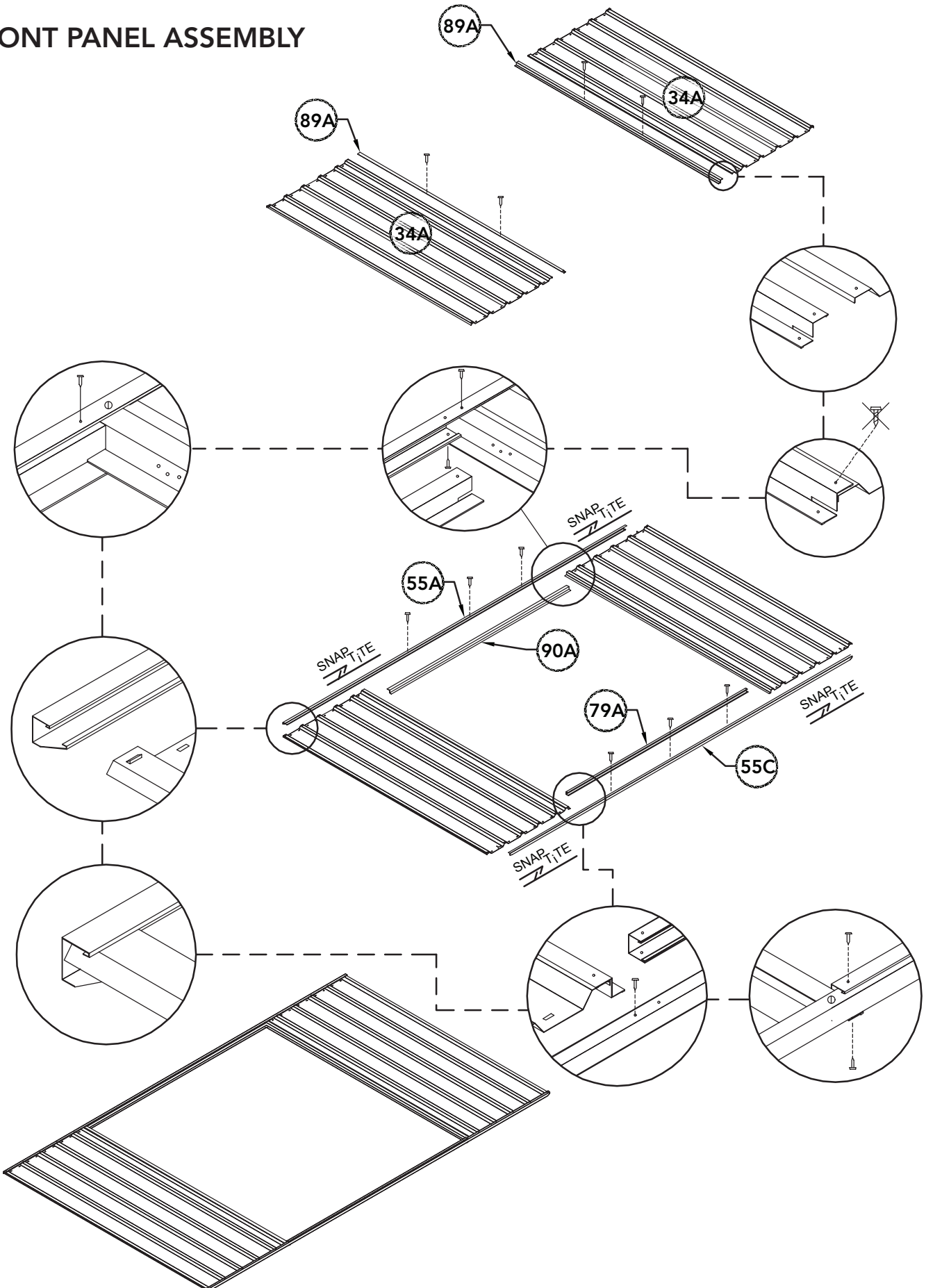

**FRONT PANEL ASSEMBLY (continued)**

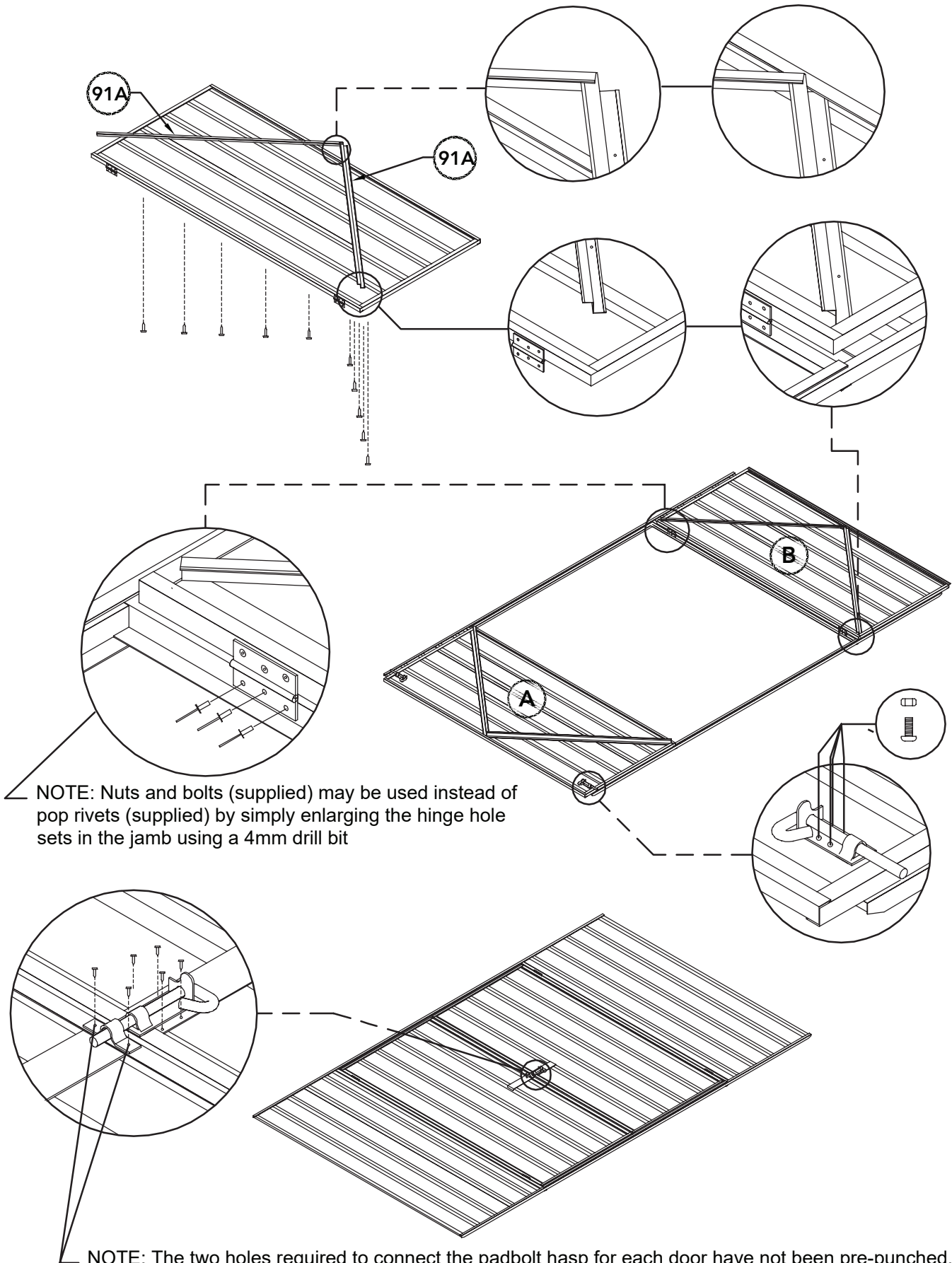

NOTE: Nuts and bolts (supplied) may be used instead of pop rivets (supplied) by simply enlarging the hinge hole sets in the jamb using a 4mm drill bit

NOTE: The two holes required to connect the padbolt hasp for each door have not been pre-punched, to allow for proper alignment. position each hasp centrally over the padbolt shaft, and drill 3mm holes and secure with screws



**FRONT PANEL ASSEMBLY (continued)**

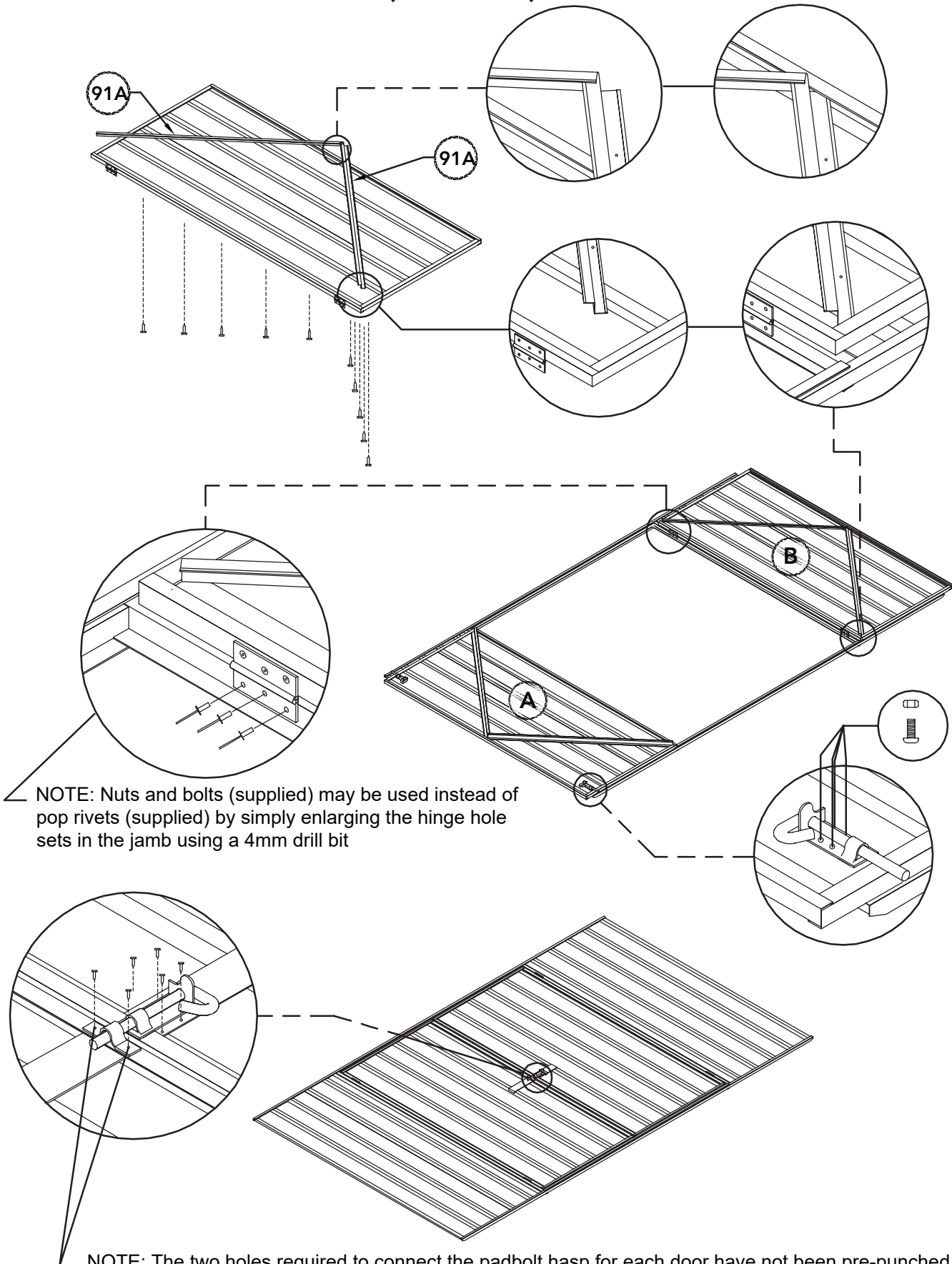

NOTE: Nuts and bolts (supplied) may be used instead of pop rivets (supplied) by simply enlarging the hinge hole sets in the jamb using a 4mm drill bit

NOTE: The two holes required to connect the padbolt hasp for each door have not been pre-punched, to allow for proper alignment. position each hasp centrally over the padbolt shaft, and drill 3mm holes and secure with screws

## PANEL CONSTRUCTION

NOTE: Take care to ensure that all wall panels are not upside down. The top channels of each panel are pre-punched for attaching roof sheeting. The base channels are not pre-punched.

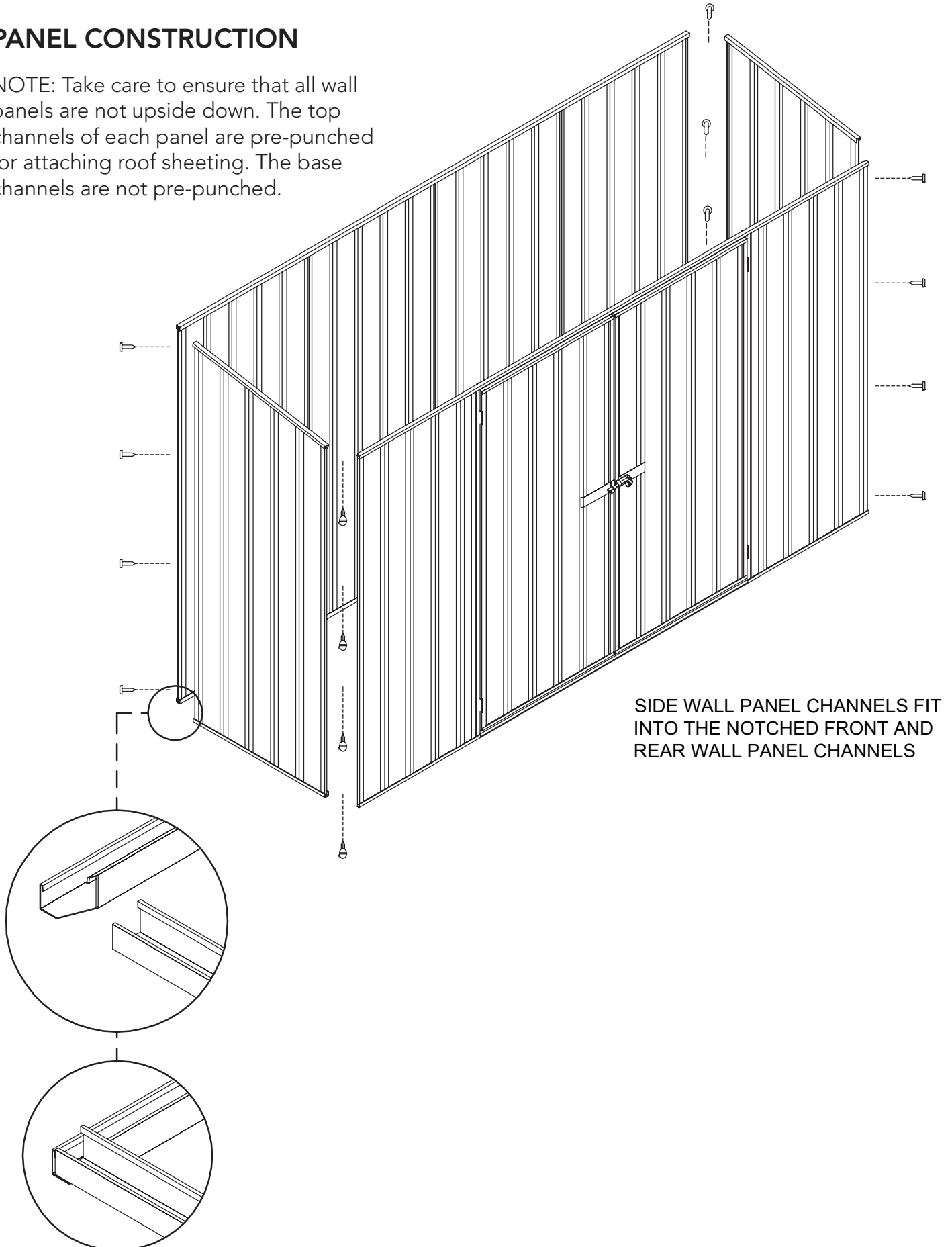

**FINAL CONSTRUCTION**

**ANCHORING OF SHED**

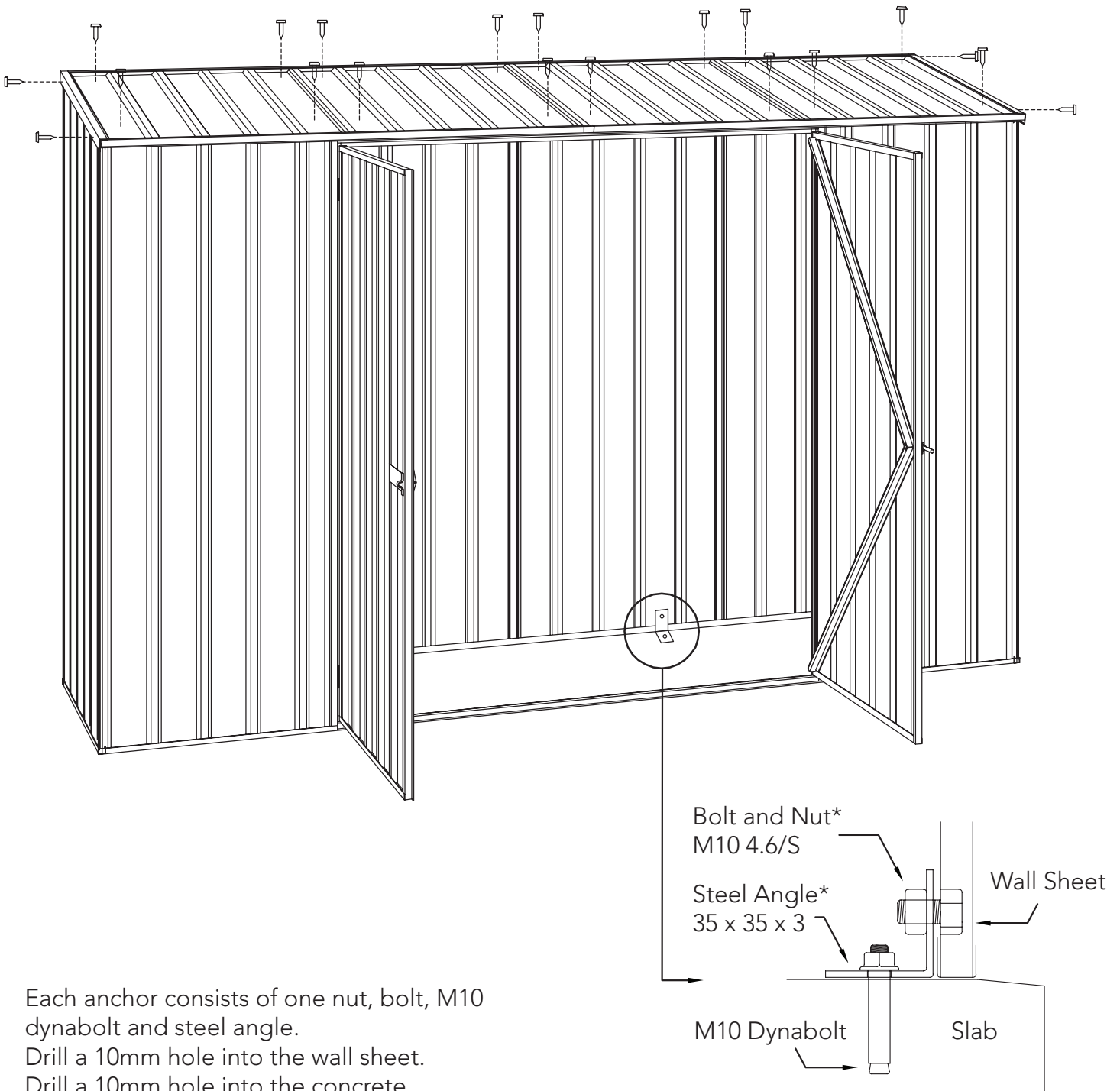
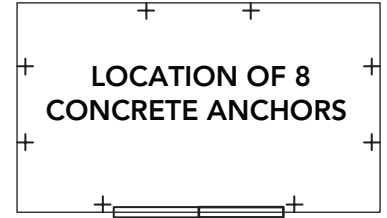

Each anchor consists of one nut, bolt, M10 dynabolt and steel angle.  
Drill a 10mm hole into the wall sheet.  
Drill a 10mm hole into the concrete.

\* Denotes hot dip galvanised finish

---

## Absco Skillion Roof Shed Notes

### General

- 1.G This instruction manual shall be read in conjunction with other consultants drawings, specifications and written instructions provided by Absco and/or their representatives.
- 2.G The drawings provided herein are for installation and structural engineering purposes only. If discrepancies are discovered within the documentation provided, these shall be brought to the attention of Absco and written approvals obtained prior to commencing the affected section of work.
- 3.G If in doubt ask.
- 4.G Until approvals from the local authorities are obtained, commencement of construction from these drawings shall not commence.
- 5.G Unless varied by the project specification, all materials and workmanship shall be undertaken in accordance with the relevant Australian standards and the by-laws and ordinances of the relevant building authorities.
- 6.G All dimensions indicated in these drawings shall be verified on site by the installation contractor. Scaling of drawings shall not be undertaken.
- 7.G Prior to commencing works on site, the contractor shall verify the position of all services in the area to ensure that the construction does not interfere with any of those services.
- 8.G During installation on site the shed structures shall be maintained in a stable condition with no part becoming overstressed or permanently deformed.

## Absco Skillion Roof Shed Notes

### Steelwork

- 1.S All structural steelwork shall have a corrosion protection system applied consistent with AS/NZS 2312-2002.
- 2.S All structural steelwork detailed within this installation manual shall be minimum Grade 550 for roll formed sections (including roof and wall sheeting) and Grade 250 for angle sections.
- 3.S All roof, and wall sheeting shall be minimum base metal thickness of 0.3mm
- 4.S All snaptite channels and jambs shall be minimum base metal thickness of 0.42mm
- 5.S All top hats shall be minimum base metal thickness of 1.0mm
- 6.S All screw fasteners shall be Phil Pan Head Zinc Plated #8 x 3/4" (STP0820)
- 7.S All bolt fasteners for anchoring shall be M10 minimum grade 4.6/S
- 8.S Installation of screw fasteners shall generally be undertaken in accordance with the relevant provisions of AS1562.

### Supporting Slab and Foundations

- 1.F The supporting slab foundation for the garden shed shall be of a minimum size indicated on the installation manual. The top surface of the formed slab shall be level and free of any irregularities which would inhibit the installation of the shed.
- 2.F The structural engineering design for the supporting slab foundation shall be undertaken by a suitably qualified structural engineer. The design shall consider all relevant provision of AS3600 and AS2870.
- 3.F Between adjacent footings or excavations, the contractor installing the slab foundation shall not exceed a rise of 1 in a run of 2 in line of slope.
- 4.F Unless approved in writing by the slab foundation engineer, the limits of excavations near existing footings shall be in accordance with that indicated below.

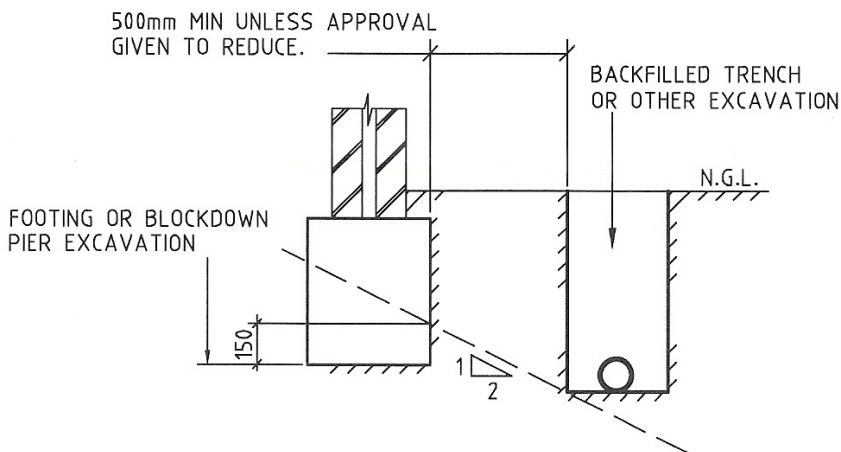

The contractor shall undertake investigatory localised excavations near existing footings to ascertain their depth prior to excavating adjacent to them. It is noted that excavating to a depth below that indicated above shall not be undertaken without the written approval from the engineer.

## Absco Sheds Storage Guidelines

- Absco Sheds are designed to be weatherproof for normal weather conditions. In the event of extreme weather conditions such as heavy rain, combined with high wind gusts, the ridge capping, sheeting joints, screw fixings etc., may exhibit minor deformations which may allow some water entry. These areas should be checked regularly to ensure that maximum strength and protection is maintained.
- Other weather conditions such as extreme heat and extreme cold, moist or dry air can influence the effects of concrete floor moisture and/or condensation on the underside of the roof sheets.
- Absco Sheds and storage units are primarily used for storage of garden equipment such as lawnmowers, wheelbarrows, garden tools etc. Storage items that might be adversely affected by any of the above conditions may require additional protection such as being sealed or covered by plastic sheets and/or stacked above the concrete floor on timber slats.
- Waterproof sealants may be used to offer further protection where required around joins and screw fixings, as can rubber door seals and other products which are available from most hardware outlets.
- Placement of waterproof sealants (silicone) between the base of the shed and concrete slab is not recommended, as this process can have a reverse effect, preventing excess water from escaping, resulting with water accumulating and being trapped inside the shed.
- Absco accepts no responsibility for water entry, floor moisture, condensation or the condition of the Contents inside your Absco steel building arising from any of the pre-mentioned weather conditions.

## Australia Product Warranty Against Defects

- Absco Sheds, including garden sheds, garden beds, aviaries, storage units, garages, awnings and carports are made using high quality Australian made steel.
- We are pleased to advise we warrant that the steel coating will not rust, crack, flake peel or blister for **20 years** from date of purchase, when installed within Australia.
- This warranty does not apply to surface deterioration of panels caused by 'Swarf' (Tiny particles of steel debris left from cutting, grinding or drilling operations) that has not been removed after building construction, or as a result of contact with damp soil, chemicals, fertilisers or other corrosive substances.
- This warranty covers any Absco product used for normal domestic use and installed in accordance with the installation instructions.
- The warranty does NOT cover Damage caused by storms, wind, rain snow or poor foundations.
- This warranty does NOT cover ABSCO products installed in severe coastal, industrial or other highly corrosive environments. The warranty does not cover fasteners (screws, nuts, bolts, rivets, hasps or sliding padbolts).
- The warranty is limited to replacement and delivery of components and does not include any labour or installation costs. The benefits given by the warranty are in addition to your other rights and remedies under a law in relation to the goods or services to which the warranty relates.
- The warranty applies to the exclusion of all other representations, guarantees or warranties express or implied, our goods come with guarantees that cannot be excluded under the Australian consumer law and is not transferable. You are entitled to a replacement or refund for a major failure and for compensation for any other foreseeable loss or damage. You are also entitled to have the goods repaired or replaced if the goods fail to be of an acceptable quality and the failure does not amount to a major failure. For further information go to <http://www.consumerlaw.gov.au>
- Please retain a proof of purchase (sales docket or invoice) or register your warranty within 30 days of purchase here: [www.absco.com.au/register\\_warranty.php](http://www.absco.com.au/register_warranty.php)
- In the unlikely event a warranty claim is made, it must be supported by photographic evidence and details of the defect, including component part numbers, together with proof of purchase documentation (or on-line registration of purchase) and forwarded to the address below. Upon receipt of the warranty claim, the Customer Service Manager will contact you within three business days to advise you of the assessment outcome of the claim, which may include your expenses incurred in making the claim.

THE CUSTOMER SERVICE MANAGER, ABSCO INDUSTRIES, PO BOX 119 ACACIA RIDGE QLD AUSTRALIA 4110

**PHONE:** 1800 029 701 **FAX:** 07 3344 1191 **EMAIL:** [warranty@absco.com.au](mailto:warranty@absco.com.au)

Issued 01 January 2018